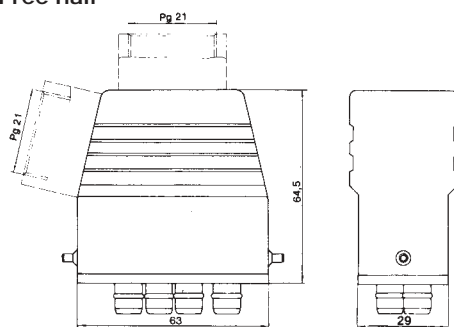
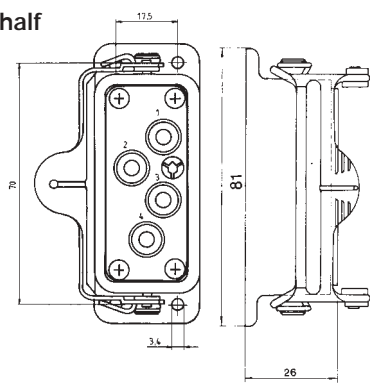
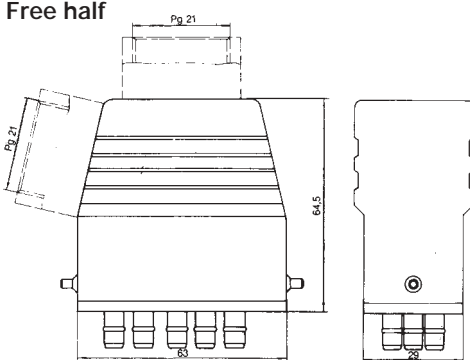
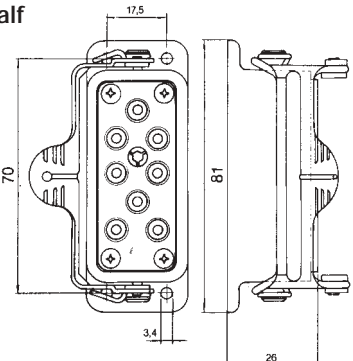

Please note the technical data on pages 2-7 and the max. working pressure on page 89

Availability: ● Short ● Medium ○ Long

	Number of elements	n.b.	Part No.	End connections	Weight [g]
Free half 	4	4	90405-1-LT016-31-1-Z13-AN	Quick push connection for hose od 6 mm id 4 mm straight and inclined entry	● 290
Fixed half 	4	4	90405-4-FT016-31-1-Z10-AN	Quick push connection for hose od 6 mm id 4 mm	● 150
Materials: carrier plates: Aluminium anodized elements: brass nickel-plated		quick push connections: brass passivated housing: light alloy hammergrey enamel Seals: NBR, low friction			

Free half 	8	2	90405-1-LT019-31-1-Z13-AO	Quick push connection for hose od 4 mm id 2 mm straight and inclined entry	● 280
Fixed half 	8	2	90405-4-FT019-31-1-Z10-AO	Quick push connection for hose od 4 mm id 2 mm	● 140
Materials: carrier plates: Aluminium anodized elements: brass nickel-plated		quick push connections: brass passivated housing: light alloy hammergrey enamel Seals: NBR, low friction			

Please note the technical data on pages 2-7 and the max. working pressure on page 89

Availability: ● Short ○ Medium ○ Long

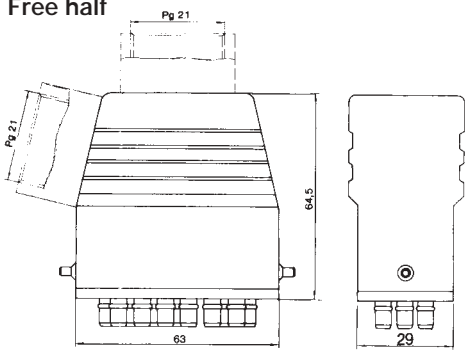
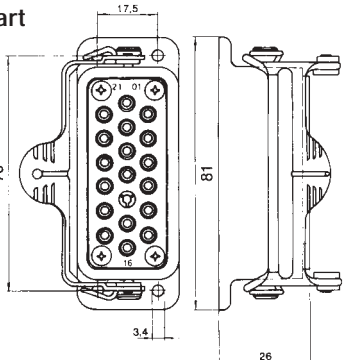
	Number of elements	n.b.	Part No.	End connections	Weight [g]	
Free half  Fixed part 	18	2	90405-1-LT001-PA-1-Z13-AA	Push ferrule connection for hose od 4 mm id 2 mm straight and inclined entry	● 240	
	18	2	90405-1-LT001-PA-1-Z13-AB	Standard:		
	18	2	90405-1-LT001-PA-1-Z13-AC	pattern U1: pattern U2:		
		18	2	90405-4-FT002-PA-0-Z10-AA	Push ferrule connection for hose od 4 mm id 2 mm straight and inclined entry	● 110
		18	2	90405-4-FT002-PA-0-Z10-AB	Standard:	
		18	2	90405-4-FT002-PA-0-Z10-AC	pattern U1: pattern U2:	

Materials:
carrier plates: Polyamide 6.6, 30 % glas fibre reinforced
plug elements: brass, nickel-plated

housings: light alloy, hammergey enamel
seals: NBR, low friction
Ferrules for push-ferrule-connections must be ordered separately.

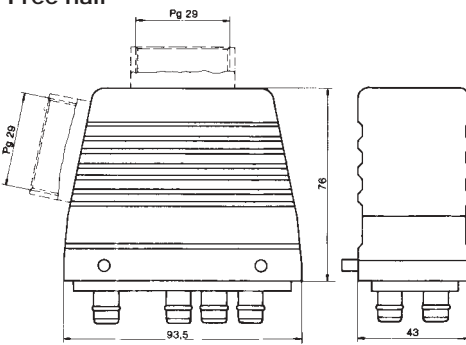
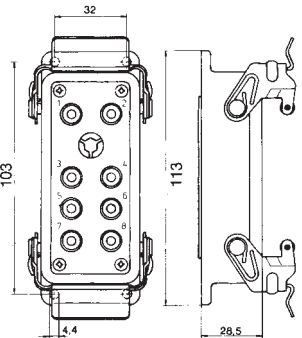
Free half  Fixed half 	8	4	90408-1-LT006-PA-1-Z19-AF	Quick push connection for hose od 6 mm id 4 mm carrier plates made of Polyamide straight and inclined end	● 440
	8	4	90408-1-LT006-31-1-Z19-AF	carrier plates made of anodized Aluminium straight and inclined end	● 520
	8	4	90408-4-FT006-PA-1-Z01-AF	Quick push connection for hose od 6 mm id 4 mm carrier plates made of Polyamide	● 210
	8	4	90408-4-FT006-31-1-Z01-AF	carrier plates made of anodized Aluminium	● 310

Materials:
carrier plates: Polyamide 6.6, 25 % glas fibre reinforced or Aluminium anodized
plug elements: brass, nickel-plated

quick push connections: brass passivated
 housings: light alloy, hammergey enamel
seals: NBR, low friction

Please note the technical data on pages 2-7 and the max. working pressure on page 89

Availability: ● Short ● Medium ○ Long

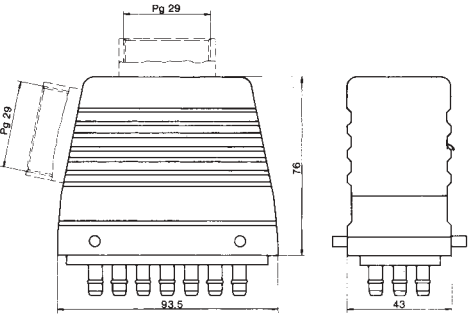
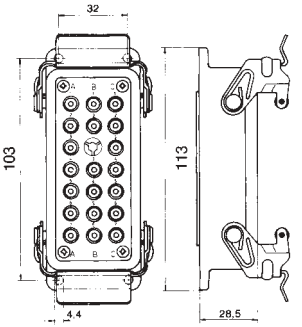
	Number of elements	n.b.	Part No.	End connections	Weight [g]
Free half  Fixed half 	20	3	90408-1-LT001-PA-1-Z19-AA	Quick push connection for hose od 4 mm id 2 mm carrier plates made of Polyamide straight and inclined entry	● 460
	20	3	90408-1-LT001-31-1-Z19-AA	carrier plates made of Aluminium straight and inclined entry	● 520
	20	3	90408-4-FT001-PA-1-Z01-AA	Quick push connection for hose od 4 mm id 2 mm carrier plates made of Polyamide	● 240
	20	3	90408-4-FT001-31-1-Z01-AA	carrier plates made of Aluminium	● 300
Materials: carrier plates: Polyamide 6.6, 30 % glas fibre reinforced or Aluminium anodized plug elements: brass, nickel-plated			quick push connections: brass passivated housings: light alloy, hammergey enamel seals: NBR, low friction		

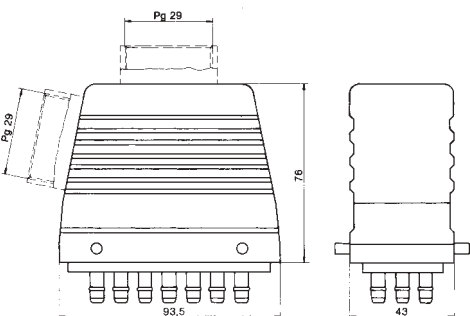
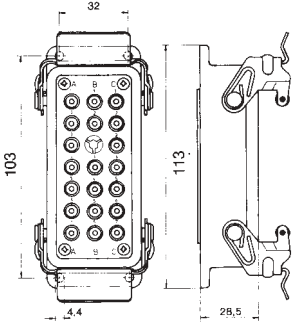
Free half  Fixed half 	20	3	90408-1-LT002-PA-1-Z19-AA	Push ferrule connection for hose od 6 mm id 4 mm straight and inclined entry. In case of inclined entry only 17 connections are useable	● 510
	20	3	90408-4-FT002-PA-0-Z01-AA	Push ferrule connection for hose od 6 mm id 4 mm	● 280
Materials: carrier plates: Polyamide 6.6, 30 % glas fibre reinforced plug elements: brass, nickel-plated			housings: light alloy, hammergey enamel seals: NBR, low friction Ferrules for push-ferrule-connections must be ordered separately.		

Spezial versions:
 spezial codings
 with fluidical and electrical
 elements on request

Materials:
 Carrier plates free half: Polyamide PA 6.6, 25 % glass fibre reinforced
 Carrier plates fixed half: Trogamid TG 35
 Retaining bar: Z 410 nickel-plated
 Thru Type Adaptors: brass nickel-plated
 Quick push connections: brass passivated
 Coding pins and bushes: stainless steel 1.4305
 Housing: light alloy, hammergrey enamel
 Seals: NBR, low friction

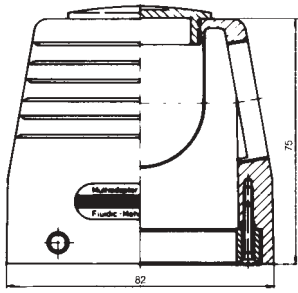
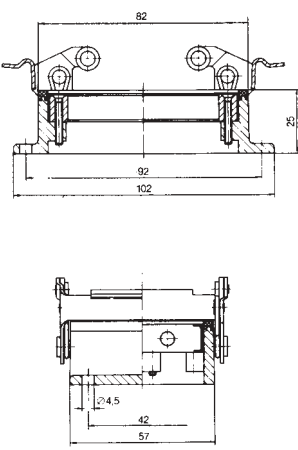

Please note the
 technical data on
 pages 2-7 and the
 max. working pressure
 on page 89

Availability: ● Short ○ Medium ○ Long

	Number of elements	End connections: A Connection for flexible, numbered plastic lines, made of Rilsan od 4 mm, id 2 mm or od 4 mm id 2,7 mm B Connection for flexible, numbered plastic lines, made of Rilsan od 6 mm, id 4 mm	Part No.		Weight [g]
			Free half	Fixed half	
Free half Straight and inclined entry 	12	12 x Quick push connection B	90410-1-LT002-PA-1-Z04-AB	90410-4-FT002-PA-1-Z03-AB	550 280
	13	4 x Quick push connection A 9 x Quick push connection B	90410-1-LT004-PA-1-Z04-AD	90410-4-FT004-PA-1-Z03-AD	520 280
	14	8 x Quick push connection A 6 x Quick push connection B	90410-1-LT003-PA-1-Z04-AC	90410-4-FT003-PA-1-Z03-AC	510 270
	15	12 x Quick push connection A 3 x Quick push connection B	90410-1-LT005-PA-1-Z04-AE	90410-4-FT005-PA-1-Z03-AE	490 270
	Fixed half 	20	20 x Quick push connection A	90410-1-LT001-PA-1-Z04-AA	90410-4-FT001-PA-1-Z03-AA

Please note the technical data on pages 2-7 and the max. working pressure on page 89

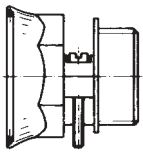
Availability: ● Short ◐ Medium ○ Long

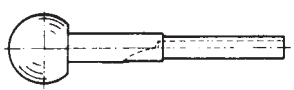
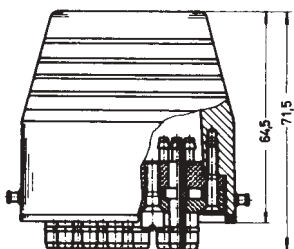
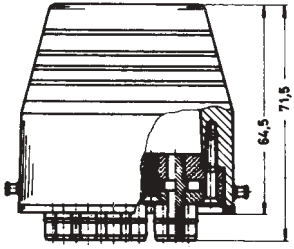
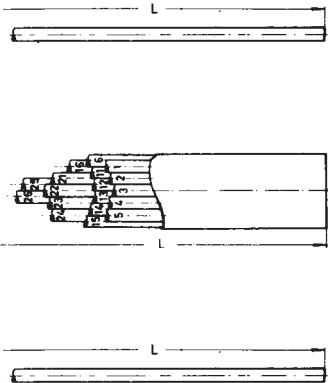
		Part No.	Materials		Weight [g]
	Hose-clamp for Type 90405 / 4-, 8-, 18-way (PG 21) for Type 90408 / 8-, 20-way (PG 29)	90405/549	Macrolon	●	25
		90408/549	Macrolon	●	48
	Ferrule Type 90405 / 18-way Type 90408 / 20-way	90405/510	brass nickel-plated	●	1
		90405/512	brass nickel-plated	●	1
	Assembly tool for push ferrule connection Type 90405 / 18-way Type 90408 / 20-way	90405/550	steel, oil-burnished	●	27
		90405/558	steel, oil-burnished	●	43
Bridge connector 	Bridge connector for Type 90405 / 18-way Ferrules for push-ferrule-connections must be ordered separately.	Standard: 90405-1-LT001-PA-1-Z03-AA	Housing: light alloy hammergey enamel Carrier plates: Polyamide Elements: brass nickel-plated Seals: Buna, low friction	●	230
Blind half 		Blind half for fixed side for Type 90405 / 18-way			
	Hoselines for Fluidic-Multicouplings numbered single hose 4x1 (od 4 mm / id 2 mm) numbers 01-06, 11-16, 21-26 numbered 19-way hosebundle 4x1 (od 4 mm / id 2 mm) numbers 01-06, 11-16, 21-26 + neutral bending radius: min. 170 mm Single hose 6x1 (od 6 mm / id 4 mm)	7-112-04010-0000-WP	Soft Polyethylene	●	
		7-113-04010-0019-WP	Soft Polyethylene	●	
		7-112-06010-0000-WP	Soft Polyethylene, black	●	