

Price index



Low noise version E4/101  
Series 381 available with  
special rubber pads design



Cleanroom test  
upon request



ESD classification:  
Electrically conductive ESD/ATEX  
version upon request



Opening e-chains®: Remove crossbars and clips - Insert screwdriver into the slot, push down, release by lever action



Remove lids/bottoms (e-tubes) - Insert screwdriver into the slot, release by lever action



When to use the Series 380/390/R780:

- If a low-noise version is required
- At very high speed and/or acceleration
- For long travels
- For high additional loads
- Also available without camber



When not to use it:

- If long side-mounted, unsupported length is required  
▶ Series E4.42, page 7.60
- If an extrem vibration-free e-chain® is necessary  
▶ Series E6.40, page 8.56  
▶ Series R6.40, page 8.62

- ❶ Crossbars on e-chain® removable along both radii
- ❷ Stop dog with "brake" for noise reduction
- ❸ Closed and open styles can be combined
- ❹ Hinged snap-open removable lids along outer radius of e-tube
- ❺ Numerous interior separation possibilities
- ❻ Optimized glide pads with lateral wear allowance
- ❼ Wide, rounded plastic crossbars - cable friendly
- ❽ Integrated strain relief possible
- ❾ KMA mounting brackets with attachment points on all sides
- ❿ Locking or pivoting mounting brackets available
- ⓫ e-chains® also available with reverse bending radius "RBR"



Also available as E4/00-NC without camber: 380-NC



Order example complete e-chain®

Please indicate chain-lengths or number of links Example: 5 m or 75 links

5 m 380.20.300.0

e-chain®

with 2 separators 382 assembled every 2<sup>nd</sup> link

Interior separation

1 set 3800.20.1.12.C

Mounting bracket



### Unsupported length

$FL_G$  = with straight upper run  
 $FL_B$  = with permitted sag  
 Further information ► Design, page 1.12

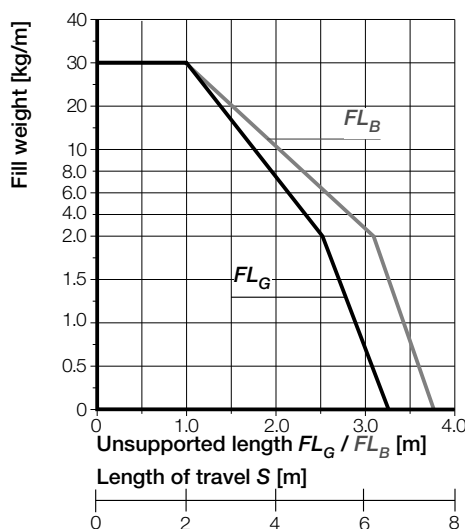
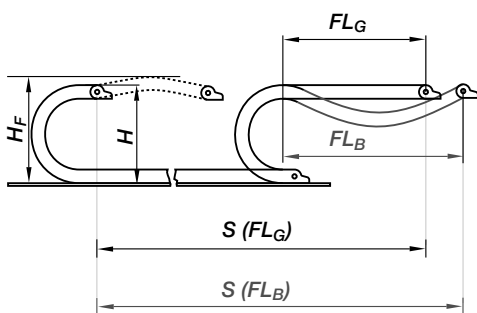

- $S$  = Length of travel
  - $R$  = Bending radius
  - $H$  = Nominal clearance height
  - $H_F$  = Required clearance height
  - $H_{RI}$  = Trough inner height
  - $D$  = Overlength e-chain\* radius in final position
  - $K = \pi \cdot R + \text{"safety"}$
  - $D_2$  = Over length - long travels, gliding
  - $K_2$  = \*Further add-on
  - $H_2$  = \*Mounting height
- \*if the mounting bracket location is set lower

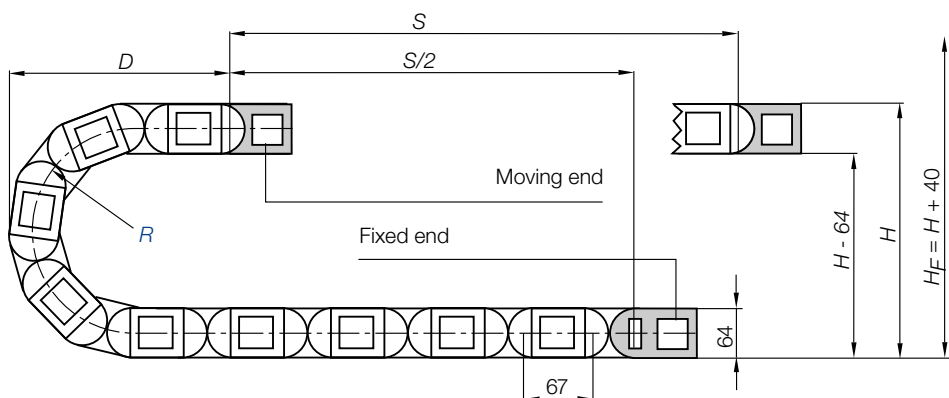

Pitch = 67 mm/link    Links/m = 15 (1005 mm)    Chain length =  $S/2 + K$

R	075	100	115	125	150	170	200	215	250	300	350
$H_{+25}^0$	215	265	295	315	365	405	465	495	565	665	765
D	174	199	214	224	249	269	299	314	349	399	449
K	370	450	500	530	610	670	765	810	920	1080	1235
$H_2$	151	201	231	186	186	186	186	186	186	186	186
$D_2^{+25}$	174	199	214	475	570	620	780	865	1030	1150	1500
$K_2$	370	450	500	804	938	1072	1340	1407	1675	1943	2412

### Other installation methods

- Vertical, hanging  $\leq 100$  m
- Vertical, standing  $\leq 6$  m
- Side mounted, unupp.  $\leq 2$  m
- Rotary requires further calculation
- Unsupported length of upper run = upon request



### Short travels - unsupported

Unsupported e-chains® feature positive camber over short travels. This must be accounted for when specifying the clearance height  $H_F$ . Please consult igus® if space is particularly restricted.

The required clearance height:  
 $H_F = H + 40$  mm  
 (with 2,0 kg/m fill weight)

### Long travel lengths from 12 m to max. 300 m    Chain length = $S/2 + K_2$

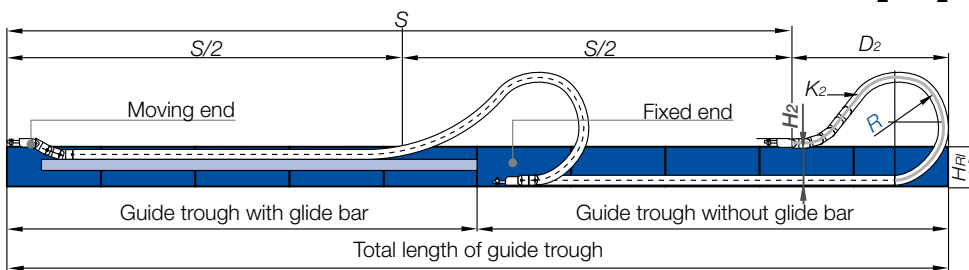

In case of travels between 8,0 and 12 m we recommend a longer unsupported length.



### Gliding, long travel applications (max. 300 m)

In this case the e-chain® upper run will be introduced in a guide trough on the lower run. We recommend to realize the engineering of such a plant by our technicians.

### Technical Data

Speed / acceleration $FL_G$	max. 20 [m/s] / max. 200 [m/s <sup>2</sup> ]
Speed / acceleration $FL_B$	max. 3 [m/s] / max. 6 [m/s <sup>2</sup> ]
Gliding speed / acceleration (maximum)	max. 10 [m/s] / max. 50 [m/s <sup>2</sup> ]
Material - permitted temperature °C	igumid G / -40° up to +120° C
Flammability class, igumid G	VDE 0304 IIC UL94 HB



Details of material properties

► page 1.38

For support of the lower run - Support Tray tool kit available ► page 9.70

System E4/00  
Inner height: 42 mm

Phone +49- (0) 22 03-96 49-800  
Fax +49- (0) 22 03-96 49-222

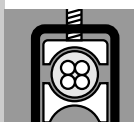

► page 7.255

igus® e-chainsystems®

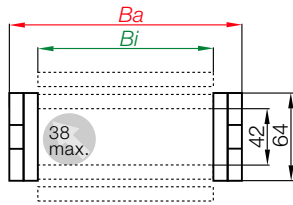

Part No. structure

380. 400. 300. 0

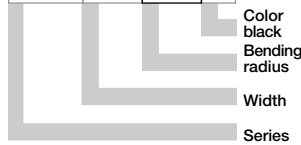

Series 380 - e-chain® with crossbars every link

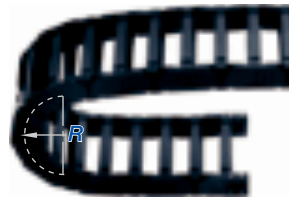

- Crossbars every link
- For rigid hydraulic hoses
- For applications particularly demanding
- Can be opened from two sides



Phone +49- (0) 22 03-96 49-800  
Fax +49- (0) 22 03-96 49-222



Series 390 - e-chain® with crossbars every 2<sup>nd</sup> link

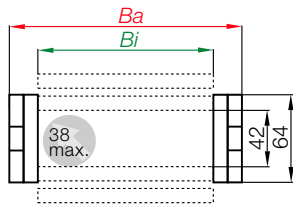

Part No. structure

390. 400. 300. 0

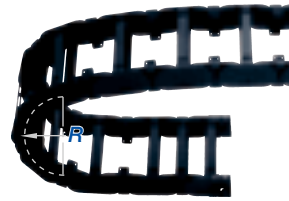

- Crossbars every 2<sup>nd</sup> link = Standard
- For nearly every situation
- Can be opened from two sides
- Easy assembly
- Stable
- Attractive price



igus® GmbH  
51147 Cologne

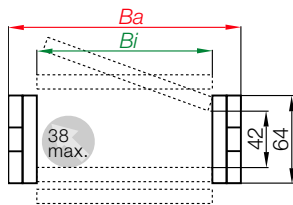

Part No. structure

780. 25. 300. 0



Series R780 - Fully enclosed e-tube



- Fully enclosed
- Excellent cable protection against dirt
- Protection against hot chips (up to 900°C)
- Lids along the entire inner radius are completely removable. Lids along the entire outer radius are single sided snap-open with a hinge on the other side to keep them attached to the chain or completely removable.



Internet: [www.igus.eu](http://www.igus.eu)  
E-mail: [info@igus.de](mailto:info@igus.de)

Low-noise! Special low-noise version with rubber pads

Series 381 - Order example: 381.15.250.0

Further information:

[www.igus.de](http://www.igus.de) or phone +49-(0) 22 03-96 49-800



Part No.		<i>Bi</i>	<i>Ba</i>	380	390	R780
		[mm]	[mm]	[kg/m]	[kg/m]	[kg/m]
380/390/780.05...	<input type="checkbox"/> .0*	50	76	≈ 2,06	≈ 1,98	≈ 2,25
380/390.06.....	<input type="checkbox"/> .0	68	94	≈ 2,09	≈ 1,99	-
380/390/780.07...	<input type="checkbox"/> .0	75	101	≈ 2,12	≈ 2,01	≈ 2,38
380/390.087.....	<input type="checkbox"/> .0	87	114	≈ 2,18	≈ 2,04	-
380/390/780.10...	<input type="checkbox"/> .0	100	126	≈ 2,25	≈ 2,08	≈ 2,60
380/390/780.11...	<input type="checkbox"/> .0	108	134	≈ 2,30	≈ 2,10	≈ 2,65
380/390.112.....	<input type="checkbox"/> .0	112	139	≈ 2,30	≈ 2,10	-
380/390/780.12...	<input type="checkbox"/> .0	125	151	≈ 2,40	≈ 2,15	≈ 2,81
380/390.137.....	<input type="checkbox"/> .0	137	164	≈ 2,44	≈ 2,17	-
380/390/780.15...	<input type="checkbox"/> .0	150	176	≈ 2,53	≈ 2,21	≈ 3,07
380/390.162.....	<input type="checkbox"/> .0	162	189	≈ 2,55	≈ 2,22	-
380/390/780.17...	<input type="checkbox"/> .0	168	194	≈ 2,62	≈ 2,26	≈ 3,24
380/390.18.....	<input type="checkbox"/> .0	175	201	≈ 2,62	≈ 2,26	-
380/390.187.....	<input type="checkbox"/> .0	187	214	≈ 2,69	≈ 2,30	-
380/390/780.20...	<input type="checkbox"/> .0	200	226	≈ 2,77	≈ 2,33	≈ 3,53
380/390.212.....	<input type="checkbox"/> .0	212	239	≈ 2,84	≈ 2,37	-
380/390.23.....	<input type="checkbox"/> .0	225	251	≈ 2,92	≈ 2,41	-
380/390.237.....	<input type="checkbox"/> .0	237	264	≈ 2,96	≈ 2,43	-
380/390/780.25...	<input type="checkbox"/> .0	250	276	≈ 3,05	≈ 2,47	≈ 4,33
380/390.262.....	<input type="checkbox"/> .0	262	289	≈ 3,06	≈ 2,48	-
380/390.28.....	<input type="checkbox"/> .0	275	301	≈ 3,17	≈ 2,53	-
380/390.29.....	<input type="checkbox"/> .0	287	314	≈ 3,19	≈ 2,54	-
380/390/780.30...	<input type="checkbox"/> .0	300	326	≈ 3,32	≈ 2,61	≈ 4,89
380/390.312.....	<input type="checkbox"/> .0	312	339	≈ 3,34	≈ 2,62	-
380/390.325.....	<input type="checkbox"/> .0	325	351	≈ 3,41	≈ 2,66	-
380/390.337.....	<input type="checkbox"/> .0	337	364	≈ 3,46	≈ 2,68	-
380/390.350.....	<input type="checkbox"/> .0	350	376	≈ 3,68	≈ 2,79	-
380/390.362.....	<input type="checkbox"/> .0	362	389	≈ 3,74	≈ 2,82	-
380/390.375.....	<input type="checkbox"/> .0	375	402	≈ 3,79	≈ 2,84	-
380/390.387.....	<input type="checkbox"/> .0	387	414	≈ 3,85	≈ 2,87	-
380/390.400.....	<input type="checkbox"/> .0	400	426	≈ 3,90	≈ 2,90	-

## Hot Chips up to 850°C

e-tubes that repel hot chips, up to 850°C. Some applications, depending on amount and size of the chips, can burn or melt the surface. That is no longer the case with the igus® "igumid HT" material. Order example: **Full e-tube made of HT\*: 780.30.150.0.HT**  
Lids made of HT: **780.30.HTE.150.0**  
\*for long travels upon request  
Further Information: [www.igus.de/en/HT](http://www.igus.de/en/HT)  
**Delivery time up to 4 weeks!**



System E4/00  
Inner height: 42 mm

Phone +49- (0) 22 03-96 49-800  
Fax +49- (0) 22 03-96 49-222

### Available bending radii

R [mm] 075\*\* 100\*\* 115\*\* 125 150 170 200 215 250 300 350

Supplement Part No. with required radius. Example: 380.400.300.0

0 = standard color, other colors ▶ page 1.39 · Pitch = 67 mm/link - Links/m = 15

\*Removable lid only, no hinged option · \*\*not available for R780



Extender crossbar for large diameter hoses ▶ page 7.280



▶ page 7.255

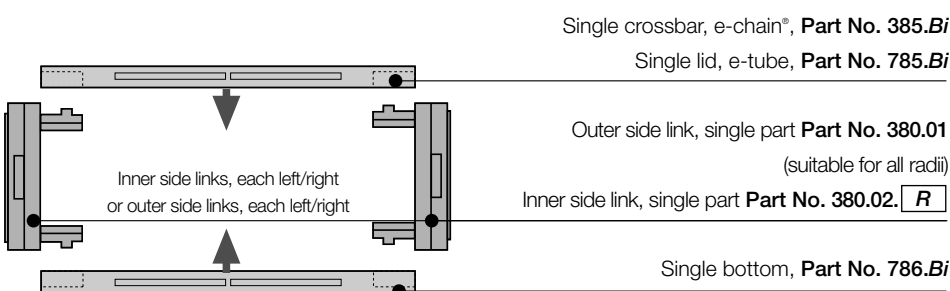

### Part No. e-chain® links, single parts

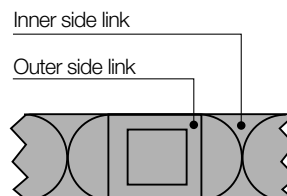

igus® e-chainsystems®



Vertical separators are used if a vertical subdivision is required. In the standard configuration, a separator is mounted at every second link. **Note:** Observe a lateral spacing of at least 25 mm (e-tube)!

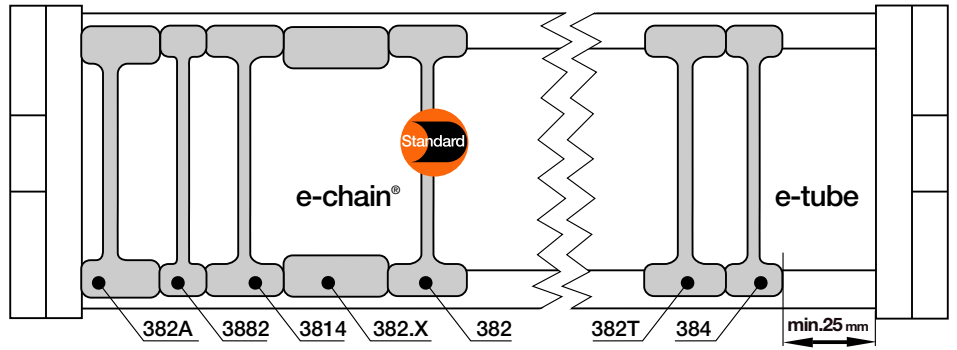

Phone +49- (0) 22 03-96 49-800  
Fax +49- (0) 22 03-96 49-222

igus® GmbH  
51147 Cologne

Internet: [www.igus.eu](http://www.igus.eu)  
E-mail: [info@igus.de](mailto:info@igus.de)



Vertical separator  
381



Vertical separator  
with a narrow base  
3881



Vertical separator  
381T



Spacer  
381.XX



Locking separator  
3804



Locking separator  
383



Asymmetric  
separator 381A

<b>Vertical separator for e-chains®</b>	
unassembled	<b>381</b>
assembled	<b>382</b>

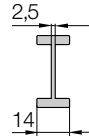

<b>Vertical separator* for e-chains®</b>	
unassembled	<b>3881</b>
assembled	<b>3882</b>

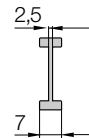

<b>Vertical separator for e-tubes</b>	
unassembled	<b>381T</b>
assembled	<b>382T</b>

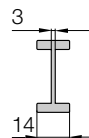

<b>Spacer* for e-chains®</b>	
unassembled	<b>381.XX</b>
assembled	<b>382.XX</b>

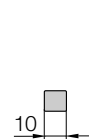

<b>Locking separator for e-chains®</b>	
unassembled	<b>3804</b>
assembled	<b>3814</b>

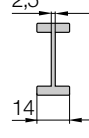

<b>Locking separator for e-tubes</b>	
unassembled	<b>383</b>
assembled	<b>384</b>

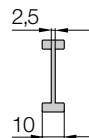

<b>Asymmetric separator for e-chains®</b>	
unassembled	<b>381A</b>
assembled	<b>382A</b>

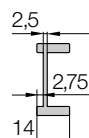

\*For side-mounted applications

**Option 1: Vertical separators and spacers**

- **Standard separator 381 for e-chains®** offers safe stability due to its broad foot design, also when used with thick cables or hoses.
- **Vertical separator 3881 with a narrow foot (7 mm) for e-chains®** with applications where a large number of small cables need to be individually separated.
- The **vertical separator 381T for e-tubes** clamps to the fixed radius and remains free along the other radius to facilitate lid removal. If installing these yourself, please ensure that they are identically aligned.
- Separators (e.g. "side mounted") for e-chains® can be fixed in their position with **spacers 381.XX**. The available inner height will be reduced by 2 mm, per spacer and side. To avoid this, the parts can be assembled on outside of the crossbar (not for long travels) **XX = width of the spacer** (available 10, 15 and 20)

**Additionally:**

- **Locking separator 3804 for e-chains®** - with increased retention force for applications exposed to very high humidity or extreme loads. The extra retention force is achieved by asymmetric claws for the crossbar. Ensure proper alignment.
- **Locking separator 383 for e-chains®** - with increased retention force for applications exposed to very high humidity or extreme loads. The extra retention force is achieved by asymmetric claws for the crossbar. Ensure proper alignment.
- **Asymmetric separator 381A for e-chains®** (not for e-tubes) with an 14-mm base, for combinations between spacers of different widths and vertical separators in side-mounted

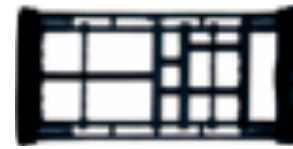
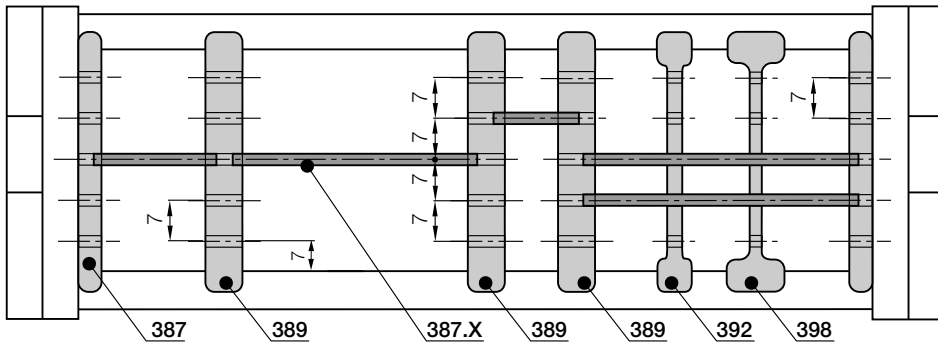

For use with many cables of differing diameters. e-chains® and e-tubes can be subdivided both vertically and horizontally. The shelves can be arranged elevator-shifted with different bottoms

### Option 2: Shelves

● Side plates 386, middle plates 388 and shelves 386.X form the basic pattern of a shelf system. Shelves of various widths can be arranged at 5 different heights (in 7 mm increments).

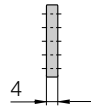

Side plate for e-chains®/e-tubes		
unassembled		386
assembled		387

● Slotted separators 391, are used for very fine subdivisions. However, they cannot be retrofitted into an existing separation system without dismantling the interior separators first.

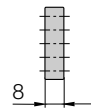

Middle plate for e-chains®/e-tubes		
unassembled		388
assembled		389

● The unilateral open slotted separator 397 can be retrofitted into an existing interior separation system without a need for dismantling the interior separators. During an installation of open slotted separators, the top and bottom notches cannot be occupied by shelves.

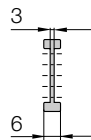

Slotted separator for e-chains®/e-tubes		
unassembled		391
assembled		392

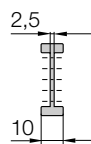

Open slotted separator for e-chains®/e-tubes		
unassembled		397
assembled		398

Width X [mm]	Part No. unassembled	Part No. assembled
018	386.18	387.18
023	386.23	387.23
025	386.25	387.25
028	386.28	387.28
033	386.33	387.33
043	386.43	387.43
050	386.50	387.50
054	386.54	387.54
062	386.62	387.62

Width X [mm]	Part No. unassembled	Part No. assembled
075	386.75	387.75
087	386.87	387.87
100	386.100	387.100
108	386.108	387.108
125	386.125	387.125
150	386.150	387.150
175	386.175	387.175
200	386.200	387.200
208	386.208	387.208



Side plate 386



Middle plate 388



Slotted separator 391



Open slotted separator 397



Shelf 386.X

Shelf

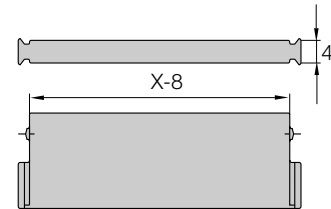

System E4/00  
Inner height: 42 mm

Phone +49- (0) 22 03-96 49-800  
Fax +49- (0) 22 03-96 49-222

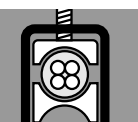
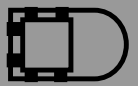



Part No. structure  
380.10 /20 /10. 200.0  
380.*Bi*1/*Bi*2/*Bi*3. R.0

### Extension links - for extremely wide e-chains® up to 3,0 m

- For applications in which particularly high fill weights necessitate extremely wide e-chains® (up to 3000 mm)
- The extension link design allows virtually limitless side-by-side attachment of chains
- The unsupported length of a chain can be increased when additional loads are required
- Extension links can be used with e-chains®, e-tubes or as a combination of both
- They are suitable for unsupported and gliding applications in a guide trough
- e-chains® with extension links are attached with KMA or steel mounting brackets

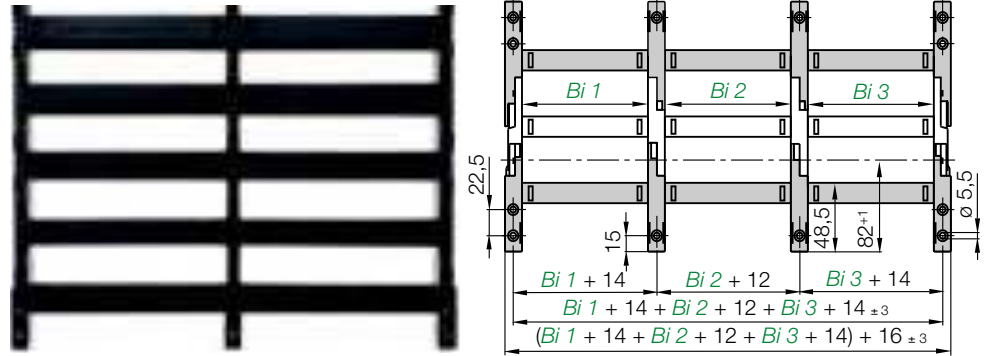

### Extender crossbars - careful guide of hoses applications

- Suitable for hoses with a maximum outer diameter of 115 mm
- Gliding operation with crossbars assembled along the outer radius and a special guide trough
- Gliding operation not guaranteed with crossbars assembled along the inner radius
- The extender crossbar can either be attached to the side links directly or can be used in combination with two stranded snap-open crossbars

Consult igus® for your extender crossbar applications. We are happy to assist you with your design layout

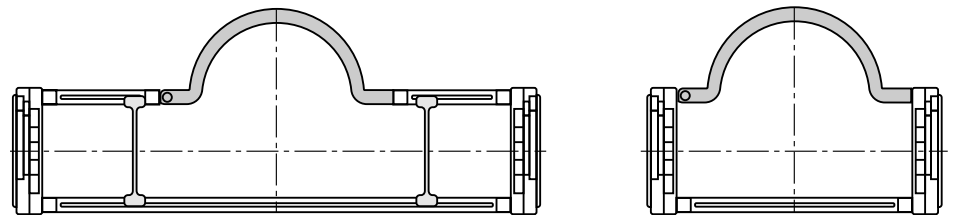

385.15RHD115 round extender crossbar combined with snap-open crossbars

385.18RD115 round strap attached directly on the side link

Part No.	Max Ø [mm] hose	Form	Installation side link	Combination with snap-open crossb.
385.15.RHD115	115	○	-	+
385.18.RD115	115	○	+	-

○ = round + = yes / - = no



### Hinged crossbars

- Typically e-chain® crossbars are completely removable. In cases where the snap-open crossbars have to remain at the open link of the e-chain®, a hinged design has been developed
- Length: 37,5 mm **Part No. 385.02** / snap-open crossbar (shortened): *Bi*-37,5 mm **Part No. 385.03**
- Please consult igus® for design assistance

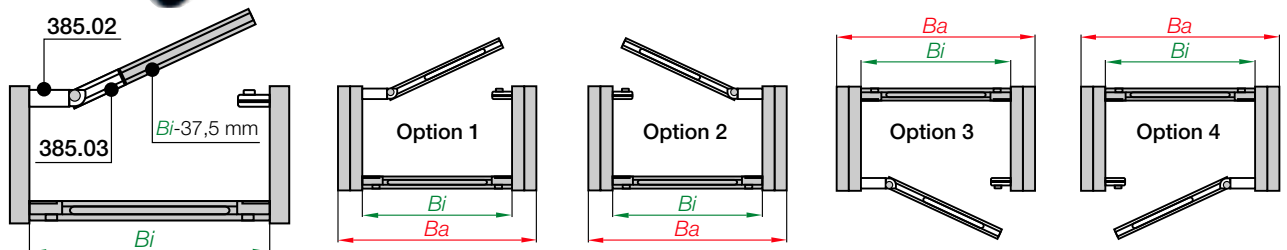

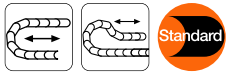

### The Standard - Option KMA\* - pivoting

- Recommended for unsupported and gliding applications
- Confined installation conditions
- Option - integrated C-profile strain relief device with chainfix clip or strain relief tiwrap plates
- Corrosion resistant
- Universally mountable with attachment capability on all sides

\*KMA = Polymer Metal Mounting Bracket

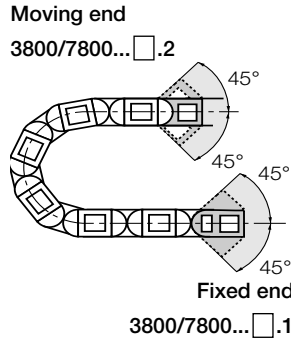

The attachment variants arising automatically by the choice of the KMA mounting bracket

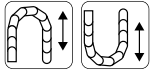
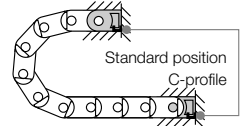

### Option KMA - locking

- Recommended for vertical hanging / standing applications

Additionally:

- Universally mountable
- C-profile option
- Corrosion resistant
- Locked connections
- At very high acceleration

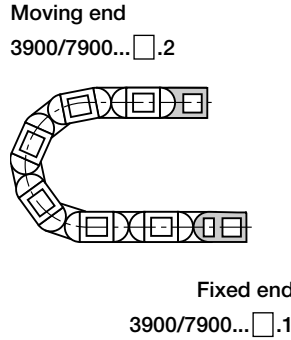

The attachment variants arising automatically by the choice of the KMA mounting bracket

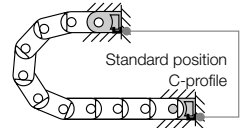

Fixed end  
3800/7800...□.1 (pivoting)  
3900/7900...□.1 (locking)

Moving end  
(pivoting) 3800/7800...□.2  
(locking) 3900/7900...□.2

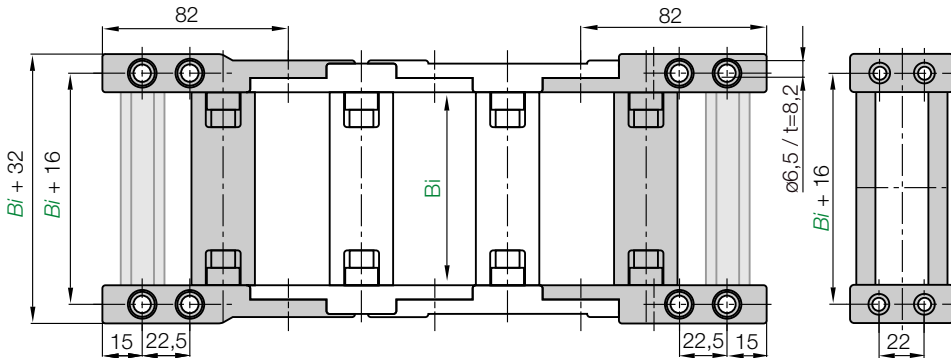

Width index	Part No. full set pivoting	Part No. full set locking	C-profile option [mm]	Width index	Part No. full set pivoting	Part No. full set locking	C-profile option [mm]
.05	3800/7800	3900/7900	.05. □.12. C 50	.23	3800	3900	.23. □.12. C 225
.06	3800	3900	.06. □.12. C 68	.237	3800	3900	.237. □.12. C 237
.07	3800/7800	3900/7900	.07. □.12. C 75	.25	3800/7800	3900/7900	.25. □.12. C 250
.087	3800	3900	.087. □.12. C 87	.262	3800	3900	.262. □.12. C 262
.10	3800/7800	3900/7900	.10. □.12. C 100	.28	3800	3900	.28. □.12. C 275
.11	3800/7800	3900/7900	.11. □.12. C 108	.29	3800	3900	.29. □.12. C 287
.112	3800	3900	.112. □.12. C 112	.30	3800/7800	3900/7900	.30. □.12. C 300
.12	3800/7800	3900/7900	.12. □.12. C 125	.312	3800	3900	.312. □.12. C 312
.137	3800	3900	.137. □.12. C 137	.325	3800	3900	.325. □.12. C 325
.15	3800/7800	3900/7900	.15. □.12. C 150	.337	3800	3900	.337. □.12. C 337
.162	3800	3900	.162. □.12. C 162	.350	3800	3900	.350. □.12. C 350
.17	3800/7800	3900/7900	.17. □.12. C 168	.362	3800	3900	.362. □.12. C 362
.18	3800	3900	.18. □.12. C 175	.375	3800	3900	.375. □.12. C 375
.187	3800	3900	.187. □.12. C 187	.387	3800	3900	.387. □.12. C 387
.20	3800/7800	3900/7900	.20. □.12. C 200	.400	3800	3900	.400. □.12. C 400
.212	3800	3900	.212. □.12. C 212				

Please insert **1** for odd number of links or **2** for even number of links

### Dimensions and order configurations

Part No. structure (pivoting)

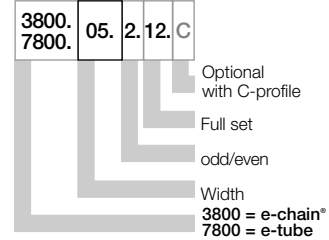

Part No. structure (locking)

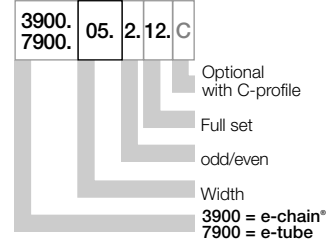

**Note:** The E4/00 System may end with either an inner side or an outer side link. Keep in mind that an outer side link always forms the first chain link at the moving end. The Part No. depends on an even or odd numbers of links. Please insert: **1** for odd number of links or **2** for even number of links

Full set, for both ends:

3800. 05. 2. 12. C (even)

Single-part order:

3800. 05. 2. 2. C (even)

Mounting bracket moving end

3800. 05. 2. 1. C (even)

Mounting bracket fixed end

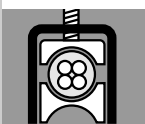
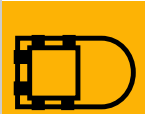





igus® chainfix steel clamps and chainfix stainless-steel clamps - max. pull forces, adjustable with hexagon socket. Available as single, double or triple clamps. **Details ▶ chapter 10**

### chainfix clamps for C-profile

Part No. single clamps		Part No. double clamps		Part No. triple clamps		Cable
steel	stainless steel	steel	stainless steel	steel	stainless steel	ø [mm]
CFX12.1	CFX12.1.E	CFX12.2	CFX12.2.E	CFX12.3	-	06 - 12
CFX14.1	CFX14.1.E	CFX14.2	CFX14.2.E	CFX14.3	-	12 - 14
CFX16.1	CFX16.1.E	CFX16.2	CFX16.2.E	CFX16.3	-	14 - 16
CFX18.1	CFX18.1.E	CFX18.2	CFX18.2.E	CFX18.3	-	16 - 18
CFX20.1	CFX20.1.E	CFX20.2	CFX20.2.E	CFX20.3	-	18 - 20
CFX22.1	CFX22.1.E	CFX22.2	CFX22.2.E	CFX22.3	-	20 - 22
CFX26.1	CFX26.1.E	CFX26.2	CFX26.2.E	-	-	22 - 26
CFX30.1	CFX30.1.E	CFX30.2	CFX30.2.E	-	-	26 - 30
CFX34.1	CFX34.1.E	CFX34.2	CFX34.2.E	-	-	30 - 34
CFX38.1	CFX38.1.E	-	-	-	-	34 - 38
CFX42.1	CFX42.1.E	-	-	-	-	38 - 42



### chainfix Clip - Modular snap-on strain relief device for C-profile

Available for all igus® e-chainsystems® with C-profiles and also suitable for assembly in the KMA mounting brackets and clip-on strain relief for crossbars. High pull forces, plug-in modular snap-on strain relief device. **Details ▶ chapter 10**

Cable ø [mm]	Part No. clamp	Part No. bottom part
04 - 08	CFC-08-M	CFC-08-C
08 - 12	CFC-12-M	CFC-12-C
12 - 16	CFC-16-M	CFC-16-C
16 - 20	CFC-20-M	CFC-20-C
20 - 24	CFC-24-M	CFC-24-C



### chainfix Nugget for the C-Profile

Strain relief for the fixation of cables up to a diameter of Ø 30 mm. Easy to assemble, without any screws and tools. Easy strain relief due to fixation with pre-harnessed cable strap, very small space requirement. **Details ▶ chapter 10**

Part No.	ø max. conduit [mm]	Width [mm]
CFN.20	20	10,8
CFN.30.52*	30	16,4
CFN.20.N35*	20	20,0

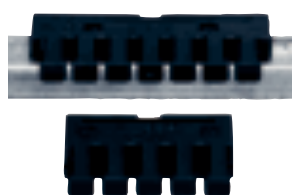

### chainfix tiwrap plates with clip-on connection for the C-profile

Can be plugged into the KMA C-profile. Easy to assemble without any screws. Easily solvable with screwdriver nevertheless safe stop. For all e-chains® with KMA and integrated C-profile. **Details ▶ chapter 10**

Part No.	Width of strain relief [mm]	Number of teeth
3050.ZC	50	5
3075.ZC	75	7



### Tiwrap plate as individual part

As individual component screwed on KMA. Can be plugged in the mounting brackets. **Details ▶ chapter 10**

Tiwrap plate	No. of teeth n	Dim. C [mm]	Dim. B [mm]	Center bore
3050.ZB	5	50	30	-
3075.ZB	7	75	55	-
3100.ZB	10	100	80	-
3115.ZB	11	115	95	-
3125.ZB	12	125	105	-
3150.ZB	15	150	130	-
3175.ZB	17	175	155	-
3200.ZB	20	200	180	+
3225.ZB	22	225	205	+
3250.ZB	25	250	230	+

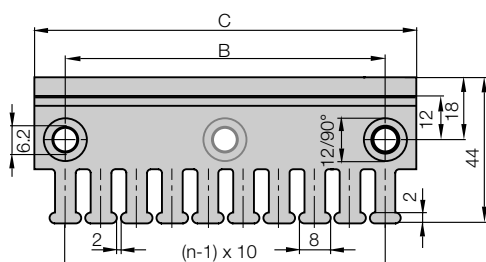
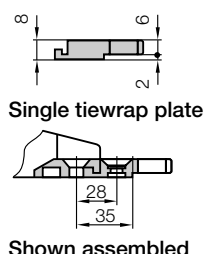

(- = no / + = yes)

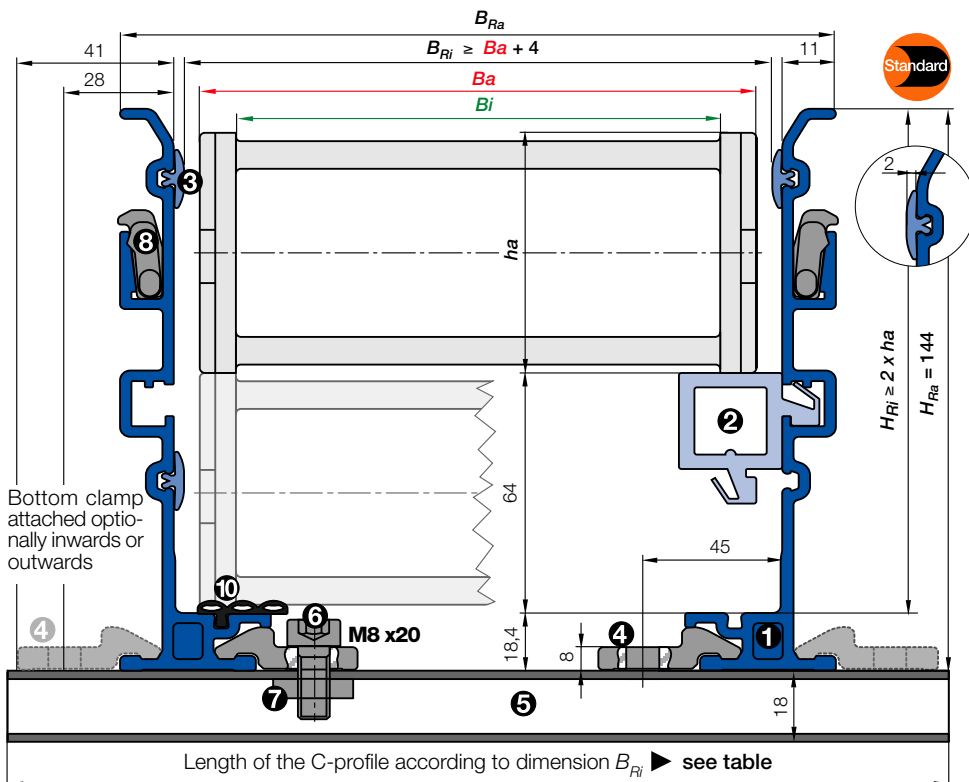

- $B_a$  = Outer width e-chains® / e-tube
- $B_i$  = Inner width e-chains® / e-tube
- $h_a$  = Outer height e-chains® / e-tube
- $H_{Ri}$  = Inner trough height
- $H_{Ra}$  = Outer trough height
- $B_{Ri}$  = Inner trough width ▶ depends on dim.  $B_a$
- $B_{Ra}$  = Outer trough width
- $n_{Mon}$  = Number of installation sets (left/right)
- $n_{Ri}$  = Number of trough sets (left/right)
- !  $H_{Ri} \geq 2 \cdot h_a$
- !  $B_{Ri} \geq B_a + 4$
- = Guide trough set    ● = Glide bar
- = Installation set "Basic"    ● = C-profile

### Installation set "Basic" with C-profile

Bottom Clamp attached optionally inwards or outwards

380.05.300.0 ▶ Order example

	Part No.	Part No.
$B_{Ri}$ [mm]	attached inwards	attached outwards
.05	80	960.40.200
.06	98	960.40.225
.07	105	960.40.225
.087	118	960.40.175
.10	130	960.40.200
.11	138	960.40.200
.112	143	960.40.200
.12	155	960.40.225
.137	168	960.40.225
.15	180	960.40.250
.162	193	960.40.250
.17	198	960.40.250
.18	205	960.40.275
.187	218	960.40.275
.20	230	960.40.300
.212	243	960.40.300
.23	255	960.40.325
.237	268	960.40.325
.25	280	960.40.350
.262	293	960.40.350
.28	305	960.40.375
.29	318	960.40.375
.30	330	960.40.400
.312	343	960.40.400
.325	355	960.40.425
.337	368	960.40.425
.350	380	960.40.450
.362	393	960.40.450
.375	406	960.40.475
.387	418	960.40.475
.400	430	960.40.500



- **Components, trough "Basic":** ① Trough side parts, aluminum, 2 m ② Glide bar, plastic, 2 m ③ Glide strips, plastic, 2 m (without glide strips on request) ⑩ Optional: Silencer profile, rubber
- **Components, installation set "Basic":** ④ Bottom clamp, aluminum ⑤ C-profile, steel galvanized ⑥ Screw M8 x 20 ⑦ Sliding nut M8 ⑧ Interface connector, plastic

### Order example: Length of travel 30 m - Center mounted for Series 380.20.300.0 with $B_{Ri} = 230$

Guide trough set (set of 2 trough side parts, incl. glide strips) **without** glide bar

Order text: 16 m guide trough without glide bar (8 x 2 m sections) Part No. 973.30.SL

Guide trough set (set of 2 trough side parts, incl. glide strips) **with** glide bar

Order text: 16 m guide trough with glide bar (8 x 2 m sections) Part No. 973.31.SL

Installation set "Basic" complete (guide trough-sets + 1)

Order text: 17 installation sets "Basic" Part No. 960.40.300

Module for the fixed end

Order text: 1 set Part No. 973.81

Option: For an additional noise dampening with silencer profile, please add Index A - Example:

Part No. 973.30.SLA

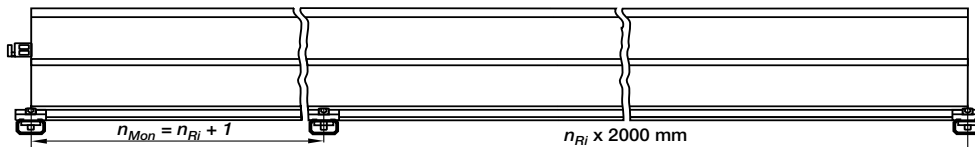

Prinzipzeichnung: Anzahl der zu montierenden Montagesets "Basic" = Anzahl der Rinnenstücke + 1



### A quick fix for mounting the stationary end of an e-chain®

With this module for the fixed end, fast and easy mounting onto the Aluminum "SuperTrough" is now possible without any drilling. Fast mounting of the e-chain® by clamping onto the aluminum trough

- Quick relocation of the stationary end
- No drilling necessary ▶ page 9.16

Insert for the installation set "Heavy-Duty": 973.50.XXX instead of (960.40.XXX) on the right column "attached outwards"

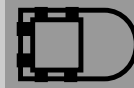

▶ chapter 10



▶ chapter 9



▶ page 7.255