

Price index



Side-mounted - unsupported

High torsional rigidity

ESD classification:
Electrically conductive ESD/ATEX version upon request



Opening e-chains®: Remove crossbars and clips - Insert screwdriver into the slot, push down, release by lever action



Remove lids/bottoms (e-tubes) - Insert screwdriver into the slot, release by lever action



When to use the Series 5050/5150/R9850:

- When high torsional forces are expected
- For side-mounted applications involving large unsupported lengths
- Due to very dirt and dusty environment
- Also available as rol e-chain®



When not to use it:

- When very long travels or high additional loads are involved
 - ▶ Series 5050HD, page 7.374
- If a simple and low-cost solution is required
 - ▶ Series 15050/R19850, page 7.216

- 1 High side-mount stability due to undercut
 - 2 High torsional rigidity
 - 3 Closed and open styles can be combined
 - 4 Hinged snap-open removable lids of e-tube
 - 5 Numerous interior separation possibilities
 - 6 Crossbars on e-chains® are removable along both radii
 - 7 Lateral glide surfaces for side-mounted operation
 - 8 Wide, rounded plastic crossbars - cable friendly
 - 9 KMA mounting brackets with attachment points on all sides
 - 10 Mounting brackets with integrated strain relief available, locking or pivoting
 - 11 e-chains® also available with reverse bending radius "RBR"
- ! "Heavy-Duty" size available. Greater unsupported length for higher loads and travels. Also available as rol e-chain® version



rol e-chain® Series 5050R/9850R available upon request

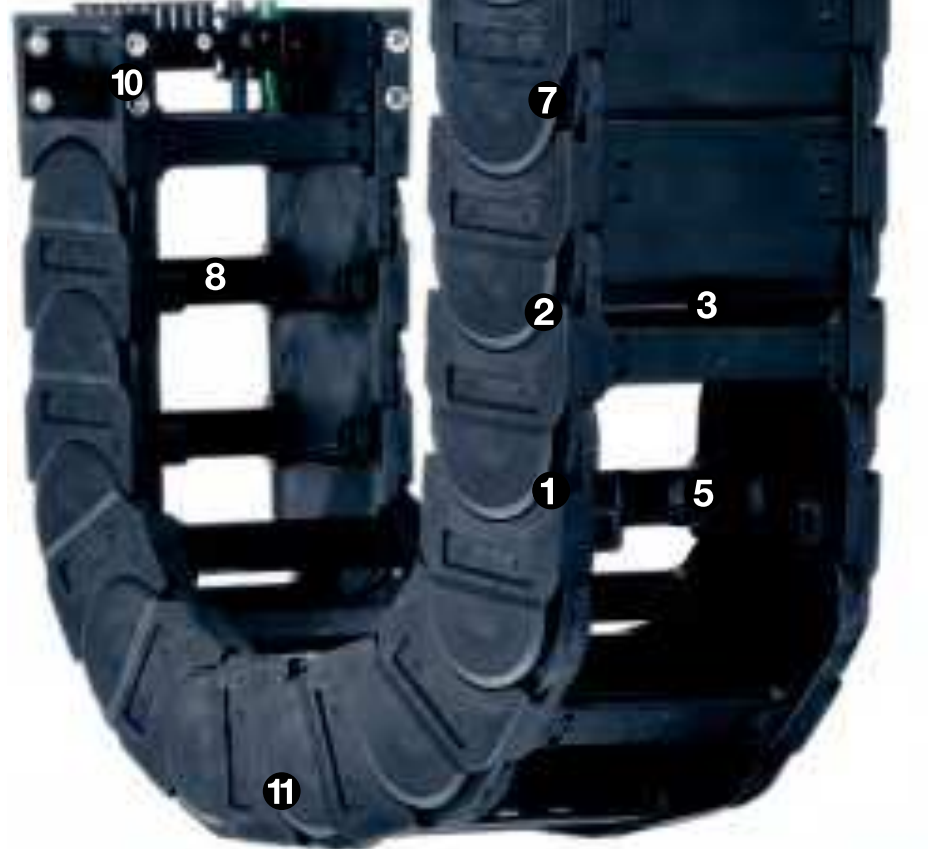

Order example complete e-chain®

Please indicate chain-lengths or number of links Example: 5 m or 55 links

5 m 5050.30.300.0

e-chain®

with 2 separators 511 assembled every 2nd link

Interior separation

1 set 50500.30.12C

Mounting bracket



Unsupported length

FL_G = with straight upper run
 FL_B = with permitted sag
 Further information ► Design, page 1.12

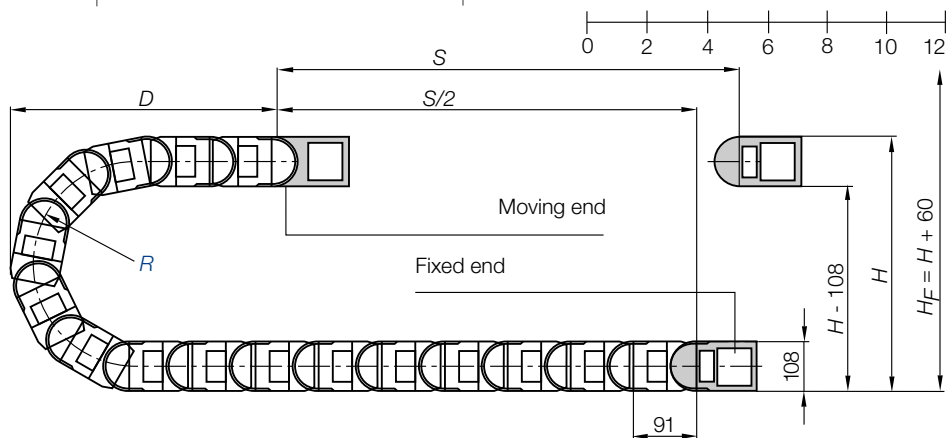
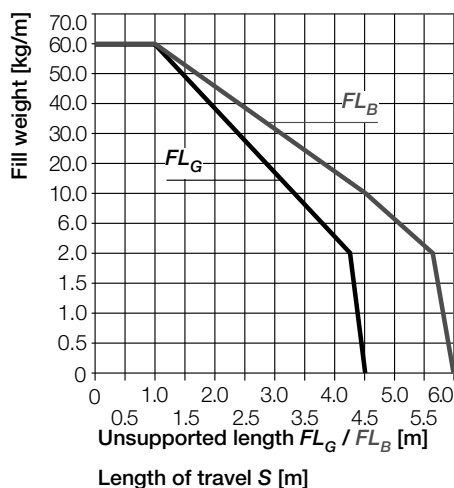
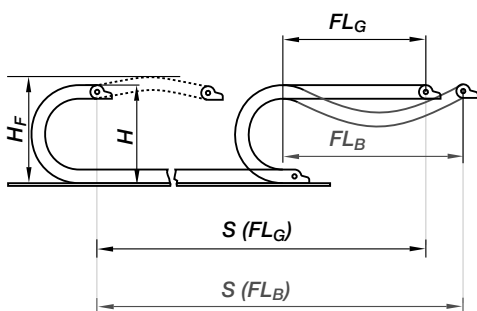

Pitch = 91 mm/link Links/m = 11 (1001 mm) Chain length = $S/2 + K$

R	150	200	250	300	350	400	500	550	600	650	1000
H_{+25}^{-0}	408	508	608	708	808	908	1108	1208	1308	1408	2108
D	295	345	395	445	495	545	645	695	745	795	1145
K	655	815	970	1125	1285	1440	1755	1910	2070	2225	3255
H_2	242	242	242	242	242	242	242	242	242	242	242
D_2^{+25}	550	800	950	1200	1550	1700	2175	2355	2580	-	-
K_2	910	1274	1638	2002	2457	2730	3458	3640	4459	-	-

- S = Length of travel
- R = Bending radius
- H = Nominal clearance height
- H_F = Required clearance height
- H_{RI} = Trough inner height
- D = Overlength e-chain* radius in final position
- $K = \pi \cdot R + \text{"safety"}$
- D_2 = Over length - long travels, gliding
- K_2 = *Further add-on
- H_2 = *Mounting height
- *if the mounting bracket location is set lower

Other installation methods

- Vertical, hanging ≤ 120 m
- Vertical, standing ≤ 6 m
- Side mounted, unupp. ≤ 3 m
- Rotary requires further calculation
- Unsupported length of upper run = upon request

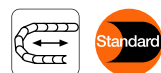

Short travels - unsupported

Unsupported e-chains® feature positive camber over short travels. This must be accounted for when specifying the clearance height H_F . Please consult igus® if space is particularly restricted.

The required clearance height:
 $H_F = H + 60$ mm
 (with 3,0 kg/m fill weight)

Long travel lengths from 10 m to max. 400 m Chain length = $S/2 + K_2$

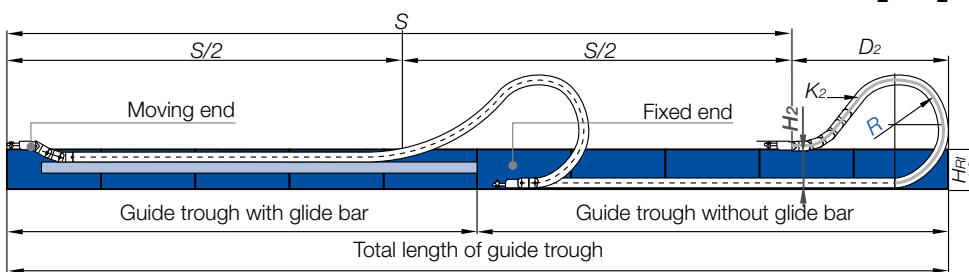

In case of travels between 4 and 10 m we recommend a longer unsupported length.



Gliding, long travel applications (max. 400 m)

In this case the e-chain® upper run will be introduced in a guide trough on the lower run. We recommend to realize the engineering of such a plant by our technicians.

Technical Data

Speed / acceleration FL_G	max. 20 [m/s] / max. 200 [m/s ²]
Speed / acceleration FL_B	max. 3 [m/s] / max. 6 [m/s ²]
Gliding speed / acceleration (maximum)	max. 10 [m/s] / max. 50 [m/s ²]
Material - permitted temperature °C	igumid G / -40° up to +120° C
Flammability class, igumid G	VDE 0304 IIC UL94 HB



Details of material properties
 ► page 1.38

For support of the lower run - Support Tray tool kit available ► page 9.70

80

System E4/4
 Inner height: 80 mm

Phone +49- (0) 22 03-96 49-800
 Fax +49- (0) 22 03-96 49-222

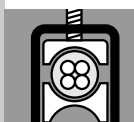

► page 7.317

igus® e-chainsystems®

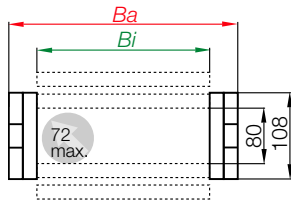

Part No. structure

5050. 30. 300. 0



Series 5050 - e-chain® with crossbars every link

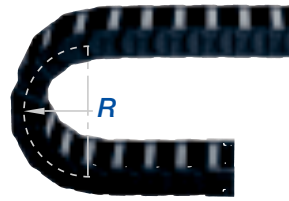

- Crossbars every link
- For rigid hydraulic hoses
- For applications particularly demanding
- Can be opened from two sides



Phone +49- (0) 22 03-96 49-800
Fax +49- (0) 22 03-96 49-222

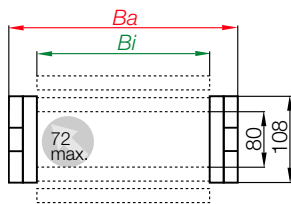

Part No. structure

5150. 30. 300. 0



Series 5150 - e-chain® with crossbars every 2nd link

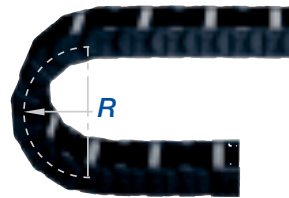

- Crossbars every 2nd link = Standard
- For nearly every situation
- Can be opened from two sides
- Easy assembly
- Stable
- Attractive price



igus® GmbH
51147 Cologne

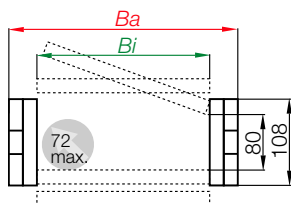

Part No. structure

9850. 30. 300. 0



Series R9850 - Fully enclosed e-tube

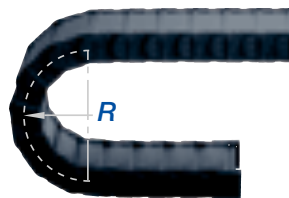

- Fully enclosed
- Excellent cable protection against dirt
- Protection against hot chips (up to 900°C)
- Lids along the entire inner radius are completely removable. Lids along the entire outer radius are single sided snap-open with a hinge on the other side to keep them attached to the chain or completely removable.



Internet: www.igus.eu
E-mail: info@igus.de

Rolling instead of gliding: rol e-chain®

Special solution for long travels. 75% less drive power (gliding application) with igus® rol e-chain®.
Series 5050R and 9850R - Order example 5050R.30.300.0
Further information: www.igus.de/en/role
or phone: +49-(0) 22 03-96 49-800



Part No.		<i>Bi</i>	<i>Ba</i>	5050	5150	R9850
		[mm]	[mm]	[kg/m]	[kg/m]	[kg/m]
5050/5150.05.	<input type="checkbox"/>	50	100	≈ 5,63	≈ 5,62	-
5050/5150.06.	<input type="checkbox"/>	65	115	≈ 5,70	≈ 5,68	-
5050/5150/9850.07.	<input type="checkbox"/>	75	125	≈ 5,79	≈ 5,70	≈ 6,24
5050/5150.08.	<input type="checkbox"/>	87	137	≈ 5,89	≈ 5,76	-
5050/5150/9850.10.	<input type="checkbox"/>	100	150	≈ 5,96	≈ 5,79	≈ 6,52
5050/5150.11.	<input type="checkbox"/>	112	163	≈ 6,09	≈ 5,85	-
5050/5150/9850.12.	<input type="checkbox"/>	125	175	≈ 6,16	≈ 5,89	≈ 6,89
5050/5150.13.	<input type="checkbox"/>	137	188	≈ 6,29	≈ 5,95	-
5050/5150/9850.15.	<input type="checkbox"/>	150	200	≈ 6,36	≈ 5,98	≈ 7,32
5050/5150.16.	<input type="checkbox"/>	162	213	≈ 6,47	≈ 6,04	-
5050/5150/9850.17.	<input type="checkbox"/>	175	225	≈ 6,58	≈ 6,09	≈ 7,58
5050/5150.18.	<input type="checkbox"/>	187	238	≈ 6,69	≈ 6,15	-
5050/5150/9850.20.	<input type="checkbox"/>	200	250	≈ 6,71	≈ 6,16	≈ 7,89
5050/5150.21.	<input type="checkbox"/>	212	263	≈ 6,82	≈ 6,22	-
5050/5150.22.	<input type="checkbox"/>	225	275	≈ 6,89	≈ 6,25	-
5050/5150.23.	<input type="checkbox"/>	237	288	≈ 7,02	≈ 6,31	-
5050/5150/9850.25.	<input type="checkbox"/>	250	300	≈ 7,11	≈ 6,36	≈ 8,61
5050/5150.26.	<input type="checkbox"/>	262	313	≈ 7,19	≈ 6,40	-
5050/5150/9850.27.	<input type="checkbox"/>	275	325	≈ 7,30	≈ 6,46	≈ 8,82
5050/5150.28.	<input type="checkbox"/>	287	338	≈ 7,33	≈ 6,47	-
5050/5150/9850.30.	<input type="checkbox"/>	300	350	≈ 7,55	≈ 6,58	≈ 9,27
5050/5150.31.	<input type="checkbox"/>	312	363	≈ 7,58	≈ 6,60	-
5050/5150.32.	<input type="checkbox"/>	325	375	≈ 7,63	≈ 6,62	-
5050/5150.33.	<input type="checkbox"/>	337	388	≈ 7,81	≈ 6,71	-
5050/5150/9850.35.	<input type="checkbox"/>	350	400	≈ 7,96	≈ 6,79	≈ 10,02
5050/5150.36.	<input type="checkbox"/>	362	413	≈ 7,97	≈ 6,80	-
5050/5150.37.	<input type="checkbox"/>	375	425	≈ 7,99	≈ 6,80	-
5050/5150.38.	<input type="checkbox"/>	387	438	≈ 8,07	≈ 6,84	-
5050/5150/9850.40.	<input type="checkbox"/>	400	450	≈ 8,27	≈ 6,94	≈ 10,98
5050/5150.41.	<input type="checkbox"/>	412	463	≈ 8,43	≈ 7,02	-
5050/5150.42.	<input type="checkbox"/>	425	475	≈ 8,58	≈ 7,10	-
5050/5150.43.	<input type="checkbox"/>	437	488	≈ 8,65	≈ 7,13	-
5050/5150.45.	<input type="checkbox"/>	450	500	≈ 8,71	≈ 7,16	-
5050/5150/9850.46.	<input type="checkbox"/>	462	513	≈ 8,73	≈ 7,17	≈ 11,44
5050/5150.47.	<input type="checkbox"/>	475	525	≈ 8,87	≈ 7,24	-
5050/5150.48.	<input type="checkbox"/>	487	538	≈ 8,88	≈ 7,26	-
5050/5150.50.	<input type="checkbox"/>	500	550	≈ 9,00	≈ 7,30	-
5050/5150.51.	<input type="checkbox"/>	512	563	≈ 9,02	≈ 7,32	-
5050/5150.52.	<input type="checkbox"/>	525	575	≈ 9,06	≈ 7,34	-
5050/5150.53.	<input type="checkbox"/>	537	588	≈ 9,22	≈ 7,41	-
5050/5150.55.	<input type="checkbox"/>	550	600	≈ 9,70	≈ 7,66	-
5050/5150.60.	<input type="checkbox"/>	600	650	≈ 9,90	≈ 7,76	-

Available bending radii

R [mm] 150* 200 250 300 350 400 500 550 600 650 1000

Supplement Part No. with required radius. Example: 5050.30.300.0

0 = standard color, other colors ▶ page 1.39 · Pitch = 91 mm/link - Links/m = 11

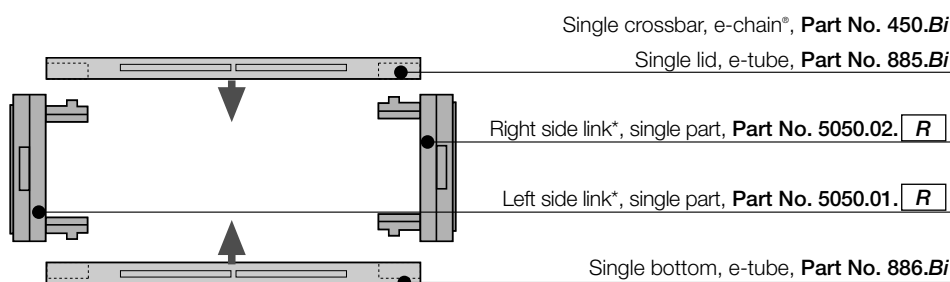

Hot Chips up to 850°C

e-tubes that repel hot chips, up to 850°C. Some applications, depending on amount and size of the chips, can burn or melt the surface. That is no longer the case with the igus® "igumid HT" material. Order example: Full e-tube made of HT*: **9850.40.250.0.HT**
 Lids made of HT: **9850.40.HTE.250.0**
*for long travels upon request
 Further Information: www.igus.de/en/HT
Delivery time up to 4 weeks!

Extreme Glider...

...with up to 70% larger glide surface. For high additional loads and high gliding speeds. Gliding applications without additional elements as well as 150% more wear allowance and improvement of service life by factor 4!
 Order example:
5050.35G.250.0
5050.45G.250.0
 Further information: phone +49-(0) 22 03-96 49-800

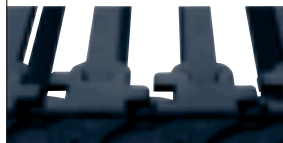

*not available for R9850



Extender crossbar for large diameter hoses ▶ page 7.368

Part No. e-chain® - links, single parts

*View from the fixed point of the e-chain®/e-tube

System E4/4
Inner height: 80 mm

Phone +49- (0) 22 03-96 49-800
Fax +49- (0) 22 03-96 49-222

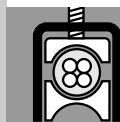

▶ page 7.317

igus® e-chainsystems®



Vertical separators are used if a vertical subdivision is required. In the standard configuration, a separator is mounted at every second link. **Note:** Observe a lateral spacing of at least 33 mm (e-tube) and 16 mm (e-chain)!

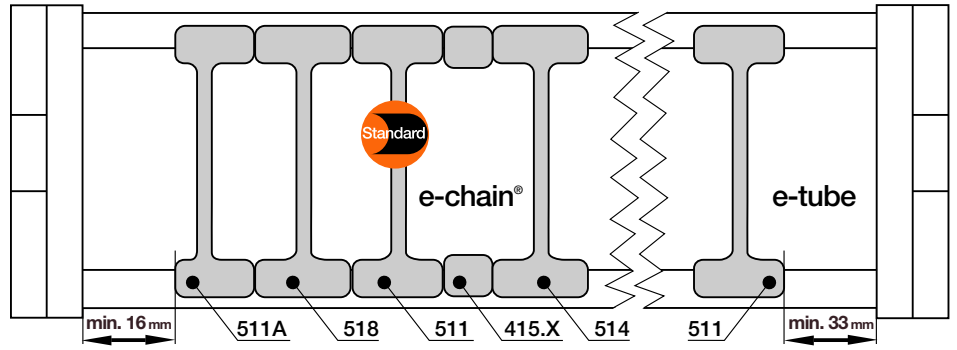

Phone +49- (0) 22 03-96 49-800
Fax +49- (0) 22 03-96 49-222

igus® GmbH
51147 Cologne

Internet: www.igus.eu
E-mail: info@igus.de



Vertical separator
501



Spacer
405.XX



Locking separator
504



Locking separator
508



Asymmetric
separator 501A

Vertical separator for e-chains®	
unassembled	501
assembled	511

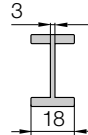

Spacer* for e-chains®	
unassembled	405.XX
assembled	415.XX



Locking separator for e-chains®	
unassembled	504
assembled	514

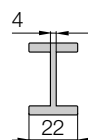

Locking separator for e-chains®	
unassembled	508
assembled	518

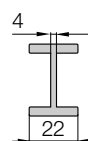

Asymmetric separator for e-chains®	
unassembled	501A
assembled	511A

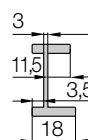

*For side-mounted applications

Option 1: Vertical separators and spacers

● **Standard separator 501 for e-chains®** offers safe stability due to its broad foot design, also when used with thick cables or hoses.

● Separators (e.g. "side mounted") for e-chains® can be fixed in their position with **spacers 405.XX**. The available inner height will be reduced by 2 mm, per spacer and side. To avoid this, the parts can be assembled on outside of the crossbar (not for long travels)
XX = width of the spacer (available 10, 15, 20, 30 and 40 mm)

Additionally:

● **Locking separator for e-chains® 504** - with increased retention force for applications exposed to very high humidity or extreme loads. If locking separators are used, the e-chain® is more difficult to open

● The **locking separator for e-chains® 508** is designed for applications exposed to extremely high humidity, for example, at composting plants. The lateral cam serves for uniform alignment of the vertical separators; if these separators are misaligned, they will inevitably get damaged on an attempt to open the e-chain®.

● **Asymmetric separator 501A for e-chains®** (not for e-tubes) with an 18-mm base, for combinations between spacers of different widths and vertical separators in side-mounted applications, for instance.

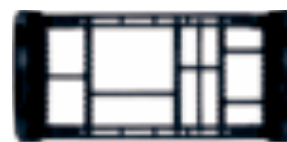
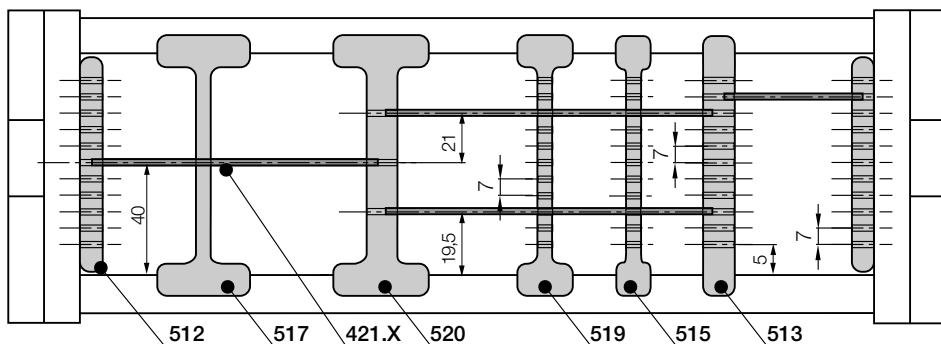

For use with many cables of differing diameters. e-chains® and e-tubes can be subdivided both vertically and horizontally. The shelves can be arranged elevator-shifted with different bottoms

Option 2: Shelves

● Side plates 502, middle plates 503 and shelves 420.X form the basic pattern of a shelf system. Shelves of various widths can be arranged at 11 different heights (in 7 mm increments).

● Locking vertical separator 510 combined with shelves. Triple slots (only for e-chains®).

● Locking separator 507 slotted - with increased retention force for applications exposed to very high humidity or extreme loads. The extra retention force is achieved by asymmetric claws for the crossbar. Ensure proper alignment.

● Slotted separators 505 are used for very fine subdivisions. However, they cannot be retrofitted into an existing separation system without dismantling the interior separators first.

● The unilateral open slotted separator 509 can be retrofitted into an existing interior separation system without a need for dismantling the interior separators. During an installation of open slotted separators, the top and bottom notches cannot be occupied by shelves.

Side plate for e-chains®/e-tubes	
unassembled	502
assembled	512

Middle plate for e-chains®/e-tubes	
unassembled	503
assembled	513

Locking vertical separator for e-chains®	
unassembled	510
assembled	520

Locking separator for e-chains®	
unassembled	507
assembled	517

Slotted separator for e-chains®/e-tubes	
unassembled	505
assembled	515

Open slotted separator for e-chains®/e-tubes	
unassembled	509
assembled	519



Side plate 502



Middle plate 503

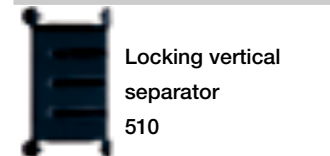

Locking vertical separator 510

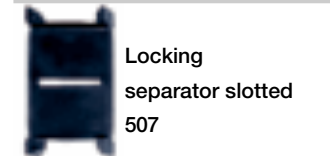

Locking separator slotted 507

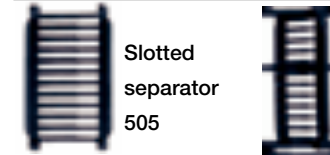

Slotted separator 505



Open slotted separator 509



Shelf 420.X

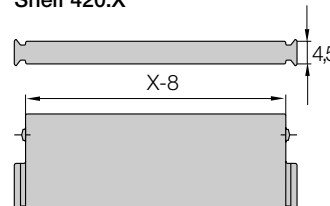

Width X [mm]	Part No. unassembled	Part No. assembled
018	420.18	421.18
023	420.23	421.23
025	420.25	421.25
028	420.28	421.28
033	420.33	421.33
043	420.43	421.43
050	420.50	421.50
062	420.62	421.62

Width X [mm]	Part No. unassembled	Part No. assembled
075	420.75	421.75
088	420.88	421.88
100	420.100	421.100
125	420.125	421.125
150	420.150	421.150
175	420.175	421.175
187	420.187	421.187
200	420.200	421.200

Additional elements for interior separation

Rollclip	
unassembled	489.27
assembled	490.27

Rollclip - minimizes abrasion of particularly sensitive hoses. The Rollclip is simply clamped onto the opening crossbar. The movable rollers compensate for relative movement between the chain and hose.

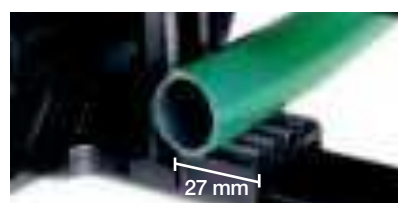

System E4/4
Inner height: 80 mm

Phone +49- (0) 22 03-96 49-800
Fax +49- (0) 22 03-96 49-222

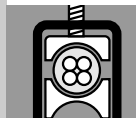

▶ page 7.317



Extension links - for extremely wide e-chains® up to 3,0 m

- For applications in which particularly high fill weights necessitate extremely wide e-chains® (up to 3000 mm)
- The extension link design allows virtually limitless side-by-side attachment of chains
- The unsupported length of a chain can be increased when additional loads are required
- Extension links can be used with e-chains®, e-tubes or as a combination of both
- They are suitable for unsupported and gliding applications in a guide trough
- e-chains® with extension links are attached with KMA or steel mounting brackets



Part No. structure
5050.10 /20 /10. .0
5050.Bi1/Bi2/Bi3. .0

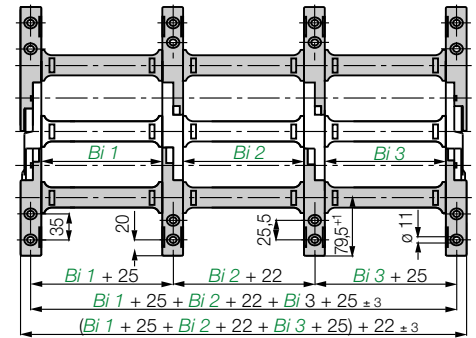

Extender crossbars - careful guide of hoses applications

- Suitable for hoses with a maximum outer diameter of 270 mm
- Gliding operation with crossbars assembled along the outer radius and a special guide trough
- Gliding operation not guaranteed with crossbars assembled along the inner radius
- The extender crossbar can either be attached to the side links directly or can be used in combination with two stranded snap-open crossbars

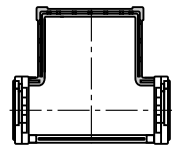
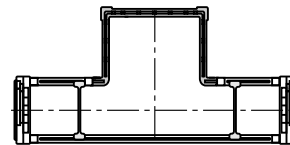
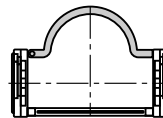
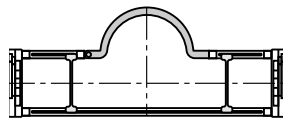

Consult igus® for your extender crossbar applications. We are happy to assist you with your design layout

Round extender crossbar with snap-open crossbars

Attached directly to the side link

Square extender crossbar with snap-open crossbars

Attached directly to the side link

Part No.	Max Ø [mm] hose	Form	Installation side link	Combination with snap-open crossb.
450.15.RHD115	115	○	-	+
450.17.RD115	115	○	+	-
450.25.D150	150	□	+	-
450.30.D200	200	□	+	-
450.35.D250	220	□	+	-
450.40.D300	270	□	+	-
450.20.HD150	150	□	-	+
450.25.HD200	200	□	-	+
450.30.HD250	220	□	-	+

○ = round □ = square + = yes / - = no



E4 snapclip

- For side-mounted applications ● Serves as a clip-on, lateral guide for hoses and cables on e-chains®
- The loops can be adjusted as required ● Compatible with many E4 e-chains® ● Stylish and economical
- One clip and one locking band are needed for each chain link ● Call us if you have any questions on project planning

Part No.	Form
450.B12	Locking clip, comprising a locking element
450.B12.200	Locking band, comprising a locking element and band; 12 x 1,5 x 200 mm

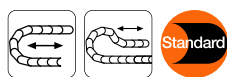

The Standard - Option KMA* - pivoting

- Recommended for unsupported and gliding applications
- Confined installation conditions
- Option - integrated C-profile strain relief device with chainfix clip or strain relief tiwrap plates
- Corrosion resistant
- Universally mountable with attachment capability on all sides

*KMA = Polymer Metal Mounting Bracket

Moving end
50500/98500...1

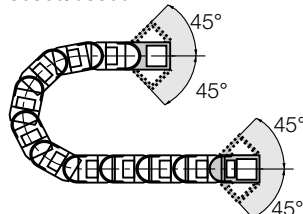

Fixed end
50500/98500...2



The attachment variants arising automatically by the choice of the KMA mounting bracket

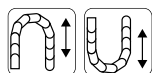
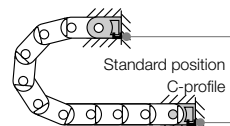

Option KMA - locking

- Recommended for vertical hanging / standing applications

Additionally:

- Universally mountable
- C-profile option
- Corrosion resistant
- Locked connections
- At very high acceleration

Moving end
51500/99500...1

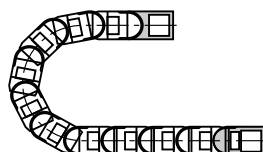

Fixed end
51500/99500...2



The attachment variants arising automatically by the choice of the KMA mounting bracket

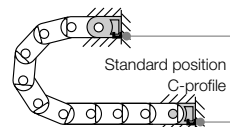

Fixed end
50500/98500...2 (pivoting)
51500/99500...2 (locking)

Moving end
(pivoting) 50500/98500...1
(locking) 51500/99500...1

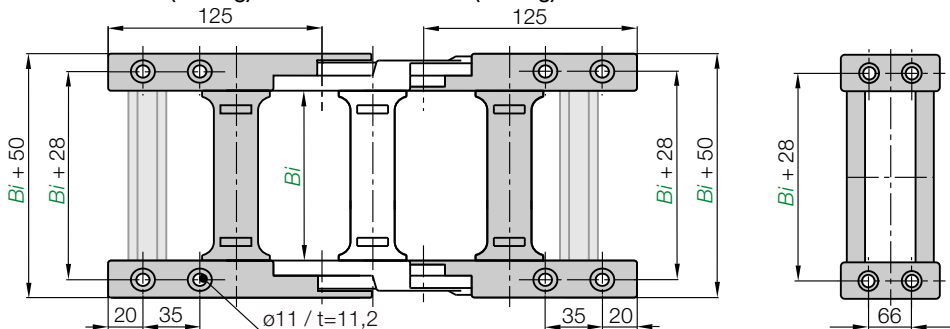

Width index	Part No. full set pivoting	Part No. full set locking	C-profile option [mm]	Width index	Part No. full set pivoting	Part No. full set locking	C-profile option [mm]
.05.	50500	51500	.05.12. C 50	.31.	50500	51500	.31.12. C 312
.06.	50500	51500	.06.12. C 65	.32.	50500	51500	.32.12. C 325
.07.	50500/98500	51500/99500	.07.12. C 75	.33.	50500	51500	.33.12. C 337
.08.	50500	51500	.08.12. C 87	.35.	50500/98500	51500/99500	.35.12. C 350
.10.	50500/98500	51500/99500	.10.12. C 100	.36.	50500	51500	.36.12. C 362
.11.	50500	51500	.11.12. C 112	.37.	50500	51500	.37.12. C 375
.12.	50500/98500	51500/99500	.12.12. C 125	.38.	50500	51500	.38.12. C 387
.13.	50500	51500	.13.12. C 137	.40.	50500/98500	51500/99500	.40.12. C 400
.15.	50500/98500	51500/99500	.15.12. C 150	.41.	50500	51500	.41.12. C 412
.16.	50500	51500	.16.12. C 162	.42.	50500	51500	.42.12. C 425
.17.	50500/98500	51500/99500	.17.12. C 175	.43.	50500	51500	.43.12. C 437
.18.	50500	51500	.18.12. C 187	.45.	50500	51500	.45.12. C 450
.20.	50500/98500	51500/99500	.20.12. C 200	.46.	50500/98500	51500/99500	.46.12. C 462
.21.	50500	51500	.21.12. C 212	.47.	50500	51500	.47.12. C 475
.22.	50500	51500	.22.12. C 225	.48.	50500	51500	.48.12. C 487
.23.	50500	51500	.23.12. C 237	.50.	50500	51500	.50.12. C 500
.25.	50500/98500	51500/99500	.25.12. C 250	.51.	50500	51500	.51.12. C 512
.26.	50500	51500	.26.12. C 262	.52.	50500	51500	.52.12. C 525
.27.	50500	51500	.27.12. C 275	.53.	50500	51500	.53.12. C 537
.28.	50500	51500	.28.12. C 287	.55.	50500	51500	.55.12. C 550
.30.	50500/98500	51500/99500	.30.12. C 300	.60.	50500	51500	.60.12. C 600

Dimensions and order configurations

Part No. structure (pivoting)

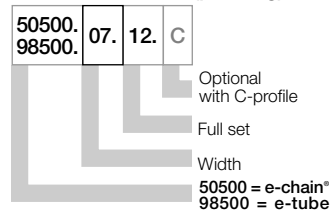

Part No. structure (locking)

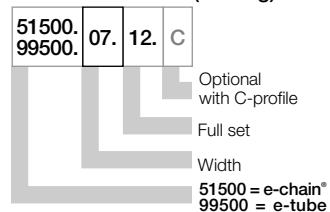

Full set, for both ends:

50500.07.12

Single-part order:

50500.07.1

Mounting bracket moving end

50500.07.2

Mounting bracket fixed end

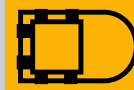

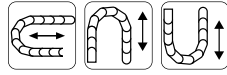

Option steel - pivoting

- For pivoting connections
- One part (two-piece) for all chain widths
- Electrically conductive

Moving end
50500.1

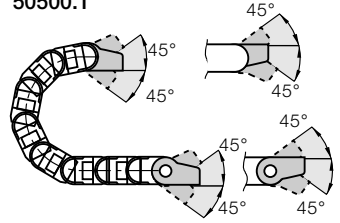

Fixed end
50500.2

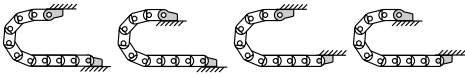

Possible installation conditions -

Further installation angles ► installation sketch

Phone +49- (0) 22 03-96 49-800
Fax +49- (0) 22 03-96 49-222

igus® GmbH
51147 Cologne

Internet: www.igus.eu
E-mail: info@igus.de

Moving end
50500.1

Fixed end
50500.2

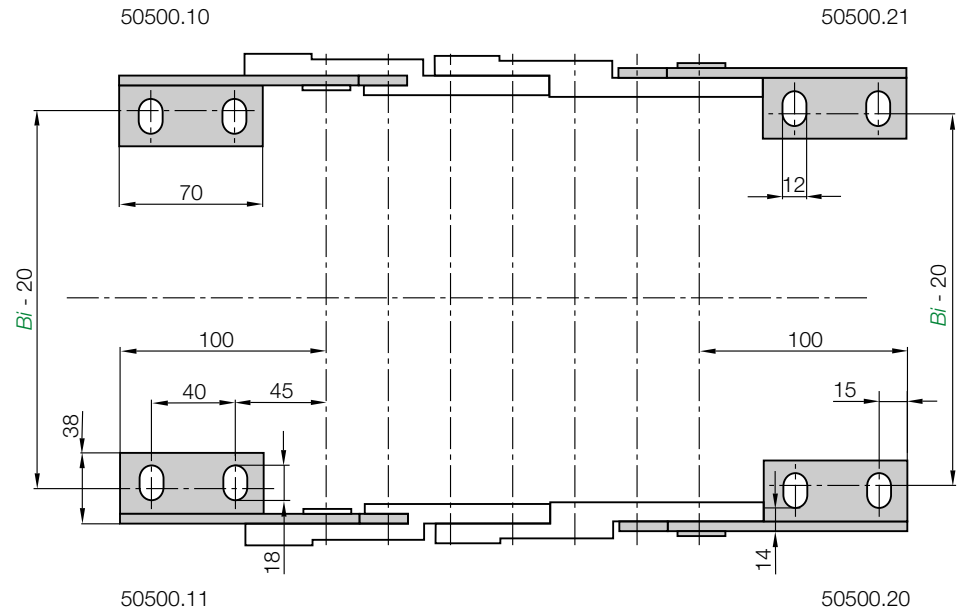

For e-chain®	Part No. full set	Bi [mm]	For e-chain®	Part No. full set	Bi [mm]
5050-5150.05	50500.12	50	5050-5150.31	50500.12	312
5050-5150.06	50500.12	65	5050-5150.32	50500.12	325
5050-5150-9850.07	50500.12	75	5050-5150.33	50500.12	337
5050-5150.08	50500.12	87	5050-5150-9850.35	50500.12	350
5050-5150-9850.10	50500.12	100	5050-5150.36	50500.12	362
5050-5150.11	50500.12	112	5050-5150.37	50500.12	375
5050-5150-9850.12	50500.12	125	5050-5150.38	50500.12	387
5050-5150.13	50500.12	137	5050-5150-9850.40	50500.12	400
5050-5150-9850.15	50500.12	150	5050-5150.41	50500.12	412
5050-5150.16	50500.12	162	5050-5150.42	50500.12	425
5050-5150.17	50500.12	175	5050-5150.43	50500.12	437
5050-5150.18	50500.12	187	5050-5150.45	50500.12	450
5050-5150-9850.20	50500.12	200	5050-5150-9850.46	50500.12	462
5050-5150.21	50500.12	212	5050-5150.47	50500.12	475
5050-5150.22	50500.12	225	5050-5150.48	50500.12	487
5050-5150.23	50500.12	237	5050-5150.50	50500.12	500
5050-5150-9850.25	50500.12	250	5050-5150.51	50500.12	512
5050-5150.26	50500.12	262	5050-5150.52	50500.12	525
5050-5150.27	50500.12	275	5050-5150.53	50500.12	537
5050-5150.28	50500.12	287	5050-5150.55	50500.12	550
5050-5150-9850.30	50500.12	300	5050-5150.60	50500.12	600

50500.12 Full set, 4 parts
2 with pin / 2 with bore

Single-part order:

50500.1 Mounting bracket
moving end, 1 part left / right

50500.2 Mounting bracket
fixed end, 1 part left / right

chainfix clamps for the C-profile

Part No. single clamps		Part No. double clamps		Part No. triple clamps		Cable steel stainless steel	Cable ø [mm]
steel	stainless steel	steel	stainless steel	steel	stainless steel		
CFX12.1	CFX12.1.E	CFX12.2	CFX12.2.E	CFX12.3	-		06 - 12
CFX14.1	CFX14.1.E	CFX14.2	CFX14.2.E	CFX14.3	-		12 - 14
CFX16.1	CFX16.1.E	CFX16.2	CFX16.2.E	CFX16.3	-		14 - 16
CFX18.1	CFX18.1.E	CFX18.2	CFX18.2.E	CFX18.3	-		16 - 18
CFX20.1	CFX20.1.E	CFX20.2	CFX20.2.E	CFX20.3	-		18 - 20
CFX22.1	CFX22.1.E	CFX22.2	CFX22.2.E	CFX22.3	-		20 - 22
CFX26.1	CFX26.1.E	CFX26.2	CFX26.2.E	-	-		22 - 26
CFX30.1	CFX30.1.E	CFX30.2	CFX30.2.E	-	-		26 - 30
CFX34.1	CFX34.1.E	CFX34.2	CFX34.2.E	-	-		30 - 34
CFX38.1	CFX38.1.E	-	-	-	-		34 - 38
CFX42.1	CFX42.1.E	-	-	-	-		38 - 42



igus® chainfix steel clamps and chainfix stainless-steel clamps - max. pull forces, adjustable with hexagon socket. Available as single, double or triple clamps. **Details ▶ chapter 10**

System E4/4
Inner height: 80 mm

Cable ø [mm]	Part No. clamp	Part No. bottom part
04 - 08	CFC-08-M	CFC-08-C
08 - 12	CFC-12-M	CFC-12-C
12 - 16	CFC-16-M	CFC-16-C
16 - 20	CFC-20-M	CFC-20-C
20 - 24	CFC-24-M	CFC-24-C

chainfix Clip - Modular snap-on strain relief device for C-profile

Available for all igus® e-chainsystems® with C-profiles and also suitable for assembly in the KMA mounting brackets and clip-on strain relief for crossbars. High pull forces, plug-in modular snap-on strain relief device. **Details ▶ chapter 10**



Part No.	ø max. conduit [mm]	Width [mm]
CFN.20	20	10,8
CFN.30.52*	30	16,4
CFN.20.N35*	20	20,0

chainfix Nugget for the C-Profile

Strain relief for the fixation of cables up to a diameter of Ø 30 mm. Easy to assemble, without any screws and tools. Easy strain relief due to fixation with pre-harnessed cable strap, very small space requirement. **Details ▶ chapter 10**



Part No.	Width of strain relief [mm]	Number of teeth
3050.ZC	50	5
3075.ZC	75	7

chainfix tiwrap plates with clip-on connection for the C-profile

Can be plugged into the KMA C-profile. Easy to assemble without any screws. Easily solvable with screwdriver nevertheless safe stop. For all e-chains® with KMA and integrated C-profile. **Details ▶ chapter 10**

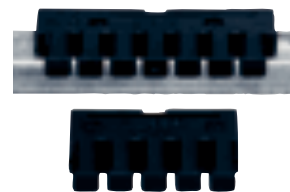

Tiewrap plate	No. of teeth n	Dim. C [mm]	Dim. B [mm]	Center bore
3050.ZB	5	50	30	-
3075.ZB	7	75	55	-
3100.ZB	10	100	80	-
3115.ZB	11	115	95	-
3125.ZB	12	125	105	-
3150.ZB	15	150	130	-
3175.ZB	17	175	155	-
3200.ZB	20	200	180	+
3225.ZB	22	225	205	+
3250.ZB	25	250	230	+

Tiewrap plate as individual part

As individual component screwed on KMA. Can be plugged in the mounting brackets. **Details ▶ chapter 10**

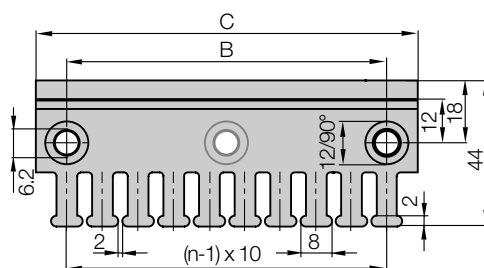

Single tiewrap plate

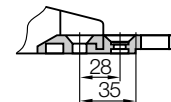

Shown assembled



- B_a = Outer width e-chains® / e-tube
- B_i = Inner width e-chains® / e-tube
- h_a = Outer height e-chains® / e-tube
- H_{Ri} = Inner trough height
- H_{Ra} = Outer trough height
- B_{Ri} = Inner trough width ▶ depends on dim. B_a
- B_{Ra} = Outer trough width
- n_{Mon} = Number of installation sets (left/right)
- n_{Ri} = Number of troughs sets (left/right)
- $H_{Ri} \geq 2 \cdot h_a$**
- $B_{Ri} \geq B_a + 4$**
- = Guide trough set = Glide bar
- = Installation set "Basic" = C-profile

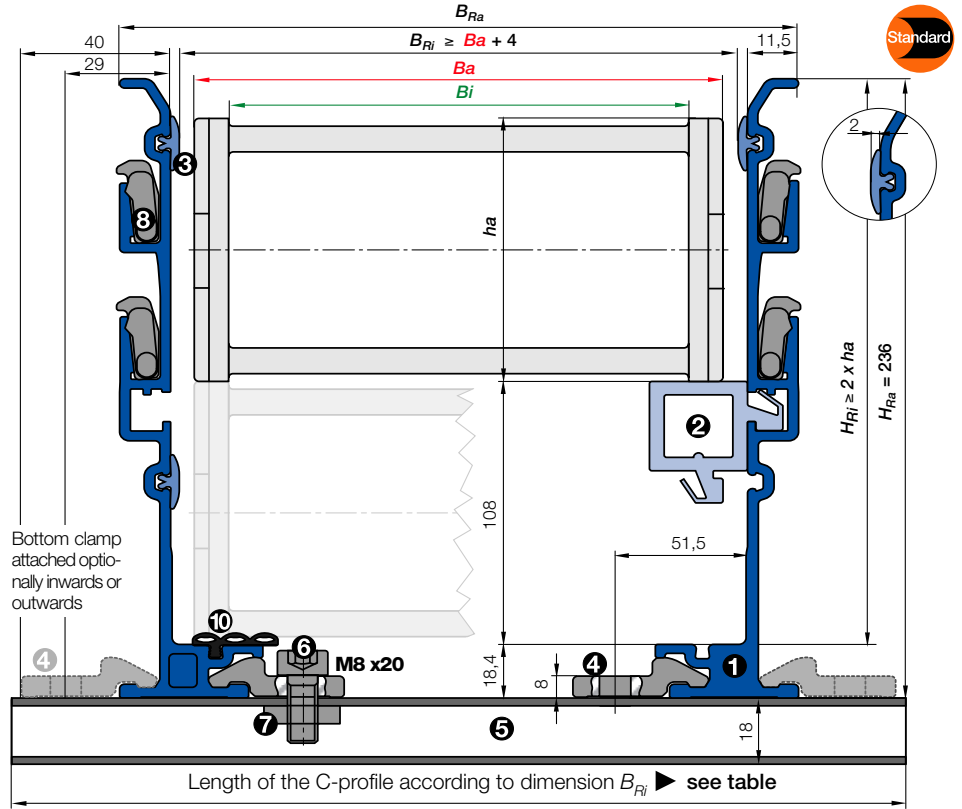

- **Components, trough "Basic":** ① Trough side parts, aluminum, 2 m ② Glide bar, plastic, 2 m ③ Glide strips, plastic, 2 m (without glide strips on request) ⑩ Optional: Silencer profile, rubber
- **Components, installation set "Basic":** ④ Bottom clamp, aluminum ⑤ C-profile, steel galvanized ⑥ Screw M8 x20 ⑦ Sliding nut M8 ⑧ Interface connector, plastic

Installation set "Basic" with C-profile

Bottom Clamp attached optionally inwards or outwards

5050.30.300.0 ▶ Order example

	B_{Ri} [mm]	Part No.	
		attached inwards	attached outwards
.05	104	-	960.50.225
.06	119	-	960.50.250
.07	129	-	960.50.250
.08	141	960.50.200	960.50.275
.10	154	960.50.225	960.50.275
.11	167	960.50.225	960.50.300
.12	179	960.50.250	960.50.300
.13	192	960.50.250	960.50.325
.15	204	960.50.275	960.50.325
.16	217	960.50.275	960.50.350
.17	229	960.50.300	960.50.350
.18	242	960.50.300	960.50.375
.20	254	960.50.325	960.50.375
.21	267	960.50.325	960.50.400
.22	279	960.50.350	960.50.400
.23	292	960.50.350	960.50.425
.25	304	960.50.375	960.50.425
.26	317	960.50.375	960.50.450
.27	329	960.50.400	960.50.450
.28	342	960.50.400	960.50.475
.30	354	960.50.425	960.50.475
.31	367	960.50.425	960.50.500
.32	379	960.50.450	960.50.500
.33	392	960.50.450	960.50.525
.35	404	960.50.475	960.50.525
.36	417	960.50.475	960.50.550
.37	429	960.50.500	960.50.550
.38	442	960.50.500	960.50.575
.40	454	960.50.525	960.50.575
.41	467	960.50.525	960.50.600
.42	479	960.50.550	960.50.600
.43	492	960.50.550	960.50.625
.45	504	960.50.575	960.50.625
.46	517	960.50.575	960.50.650
.47	529	960.50.600	960.50.650
.48	542	960.50.600	960.50.675
.50	554	960.50.625	960.50.675
.51	567	960.50.625	960.50.700
.52	579	960.50.650	960.50.700
.53	592	960.50.650	960.50.725
.55	604	960.50.675	960.50.725
.60	654	960.50.725	960.50.775

Insert for the installation set "Heavy-Duty": **975.50.XXX** instead of (960.50.XXX) on the right column "attached outwards"



Order example: Length of travel 30 m - Center mounted for Series 5050.30.300.0 with $B_{Ri} = 345$

Guide trough set (set of 2 trough side parts, incl. glide strips) without glide bar	Order text: 16 m guide trough without glide bar (8 x 2 m sections)	Part No.	975.30.SL
Guide trough set (set of 2 trough side parts, incl. glide strips) with glide bar	Order text: 16 m guide trough with glide bar (8 x 2 m sections)	Part No.	975.31.SL
Installation set "Basic" complete (guide trough-sets + 1)	Order text: 17 installation sets "Basic"	Part No.	960.50.425
Module for the fixed end	Order text: 1 set	Part No.	975.80
Option: For an additional noise dampening with silencer profile, please add Index A - Example:		Part No.	975.30.SLA



Principle sketch: Number of installation sets to be installed = Number of trough sections + 1



A quick fix for mounting the stationary end of an e-chain®

With this module for the fixed end, fast and easy mounting onto the Aluminum "SuperTrough" is now possible without any drilling. Fast mounting of the e-chain® by clamping onto the aluminum trough

- Quick relocation of the stationary end
- No drilling necessary ▶ page 9.16

Phone +49- (0) 22 03-96 49-800
Fax +49- (0) 22 03-96 49-222

igus® GmbH
51147 Cologne

Internet: www.igus.eu
E-mail: info@igus.de



Very robust E4/4 e-chain® serie 5050 with middle strap in a steel factory. Heat and dust are no problem for the maintenance-free igus® polymer e-chain® for almost 3 years

System E4/4
Inner height: 80 mm

Phone +49- (0) 22 03-96 49-800
Fax +49- (0) 22 03-96 49-222



▶ Chapter 9



▶ page 7.317



5050AX and 5050HDAX

Special e-chains® for fine dust applications

Long travel of 300 m and more are for instance often found in coal conveyors. For these travel lengths, types of loads and dirt accumulations, we have developed a special e-chainsystem® with exterior, dirt-repellent stop dogs.

- Exterior stop dogs prevent the settling of dust, dirt, chips, flour, etc.
- Mounting brackets and accessories from the E4/4 series
- Also available as heavy-duty-version - Series 5050HDAX

Series 5050AX - Order example 5050AX.30.250.0 / Series 5050HDAX - Order example 5050HDAX.30.250.0
Further information: igus.de/en/5050AX or phone +49-(0) 22 03-96 49-800